



**TRANE®**

*Cooling and Heating  
Systems and Services*

# Air-Cooled Series R® Helical-rotary Chiller

---

**Model RTAD 85-100-115-125-145-150-  
165-180**

**250 to 650 kW (50 Hz)**

**Built For the Industrial and  
Commercial Markets**



---

**RLC-PRC015-E4**

# Introduction

---

**The Trane Model RTAD Air Cooled Helical Rotary Screw Chiller: the search for Reliability, and Lower Sound Levels for today's environment.**

The Model RTAD chiller utilizes the proven design of the Trane helical rotary screw compressor; which embraces all of the design features that have made the Trane helical rotary screw compressor liquid chillers such a success since 1987.

The RTAD offers high reliability coupled with a competitive physical footprint and acoustical performance due to its advanced design, low speed/direct drive compressor and proven Series R performance.

The advantages of the Model RTAD are:

- Low sound levels.
- Designed specifically for operation with environment safe HFC-134a.
- A wide capacity range
- High Ambient units for operation up to 46°C with 915 rpm fans

The Series R Model RTAD helical rotary screw chiller is an industrial grade design built for the commercial market. It is ideal for schools, hospitals, retailers, and office buildings.

# Contents

---

<b>Introduction</b>	<b>2</b>
<b>Features and Benefits</b>	<b>4</b>
<b>Application Considerations</b>	<b>8</b>
<b>Selection Procedure</b>	<b>11</b>
<b>General Data</b>	<b>12</b>
<b>Hydraulic Data</b>	<b>28</b>
<b>Controls</b>	<b>33</b>
<b>Job Site Data</b>	<b>37</b>
<b>Electrical Data</b>	<b>38</b>
<b>Dimensional Data</b>	<b>42</b>
<b>Mechanical Specifications</b>	<b>45</b>

## Features and Benefits

### The Series R® Helical Rotary Screw Compressor

- Unequaled Reliability. The next generation Trane helical rotary screw compressor is designed, built and tested to the same demanding and rugged standards as the Trane scroll compressors, the centrifugal compressors, and the previous generation helical rotary screw compressors used in both air and water cooled chillers for more than 13 years.
- Years of research and testing. The Trane helical rotary screw compressor has amassed thousands of hours of testing, much of it at severe operating conditions beyond normal commercial air conditioning applications.
- Proven track record. The Trane Company is the world's largest manufacturer of large helical rotary compressors used for refrigeration. Over 90,000 compressors worldwide have proven that the Trane helical rotary screw compressor has a reliability rate of greater than 99.5 percent in the first year of operation - unequalled in the industry.
- Resistance to liquid slugging. The robust design of the Series R

compressor can ingest amounts of liquid refrigerant that would severely damage reciprocating compressor valves, piston rods and cylinders.

- Fewer moving parts. The helical rotary screw compressor has only two rotating parts: the male rotor and the female rotor. Unlike reciprocating compressors, the Trane helical rotary screw compressor has no pistons, connecting rods, suction and discharge valves or mechanical oil pump. In fact, a typical reciprocating compressor has 15 times as many critical parts as the Series R compressor. Fewer moving parts lead to increased reliability and longer life.
- Direct-drive, low speed, semi-hermetic compressor for high efficiency and high reliability.
- Field serviceable compressor for easy maintenance.
- Suction gas-cooled motor. The motor operates at lower temperatures for longer motor life.
- Five minute start-to-start/two minute stop-to-start anti-recycle timer allows for closer water loop temperature control.

### Improved Operating Capabilities

#### Larger Capacity Range

The Series R Model RTAD include eight sizes available in standard or high efficiency versions covering a total capacity range from 250 to 650 kW. The efficient RTAC air-cooled helical-rotary chillers are available for larger capacity up to 1500kW.

#### High Ambient Operation Capability

The High Ambient Series R Model RTAD have been designed for operation at 46°C at full load, some units can also operate at 49°C at full load using 915 rpm ZephyrWing fans. The former RTAB were using 1410 rpm fans were generating higher sound levels requiring on site additional and costly sound treatments, the RTAD will then be the ideal solution for applications having sound restrictions.

#### Improved Acoustical Performance

The sound levels of the Series R Model RTAB have been steadily improved since its introduction with the different options to reduce the sound level. With the advent of the Model RTAD, sound levels are reduced significantly with the new compressor specifically designed to minimize sound generation.

#### Superior Efficiency levels - the bar has been raised

The High Efficiency Trane Model RTAD has COP levels better than the previous RTAB and also better COP levels than conventional reciprocating chillers operating with blends of refrigerant. The modern technology of the RTAD with the efficient direct-drive compressor, the electronic expansion valve and the UCM-CLD Microprocessor Adaptive Control® has permitted Trane to achieve these efficiency levels.

- Precise Rotor Tip Clearances. Higher energy efficiency in a helical rotary screw compressor is

Figure 1 - Cutaway of a compressor

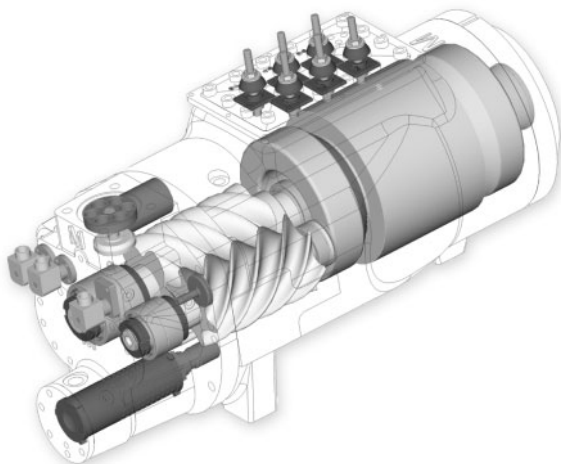

## Features and Benefits

obtained by reducing the rotor tip clearances. This next generation compressor is no exception. With today's advanced manufacturing technology, clearances can be controlled to even tighter tolerances. This reduces the leakage between high and low pressure cavities during compression, allowing for more efficient compressor operation.

- **Capacity Control and Load Matching.** The combination patented unloading system on Trane helical rotary screw compressor utilizes the variable unloading valve for the **majority** of the unloading function. This allows the compressor to modulate **infinitely** to exactly match building load and to maintain chilled water supply temperatures within  $\pm 0.3^{\circ}\text{C}$  of setpoint. Reciprocating and screw chillers that rely on stepped capacity control must run at a capacity equal to or greater than the load and typically can only maintain water temperature to around  $\pm 1^{\circ}\text{C}$ . Much of this excess capacity is lost because overcooling goes toward building latent heat removal, causing the building to be dried beyond normal comfort requirements. When the load becomes very low, the compressor also uses a step unloader valve which is a single unloading step to achieve the minimum unloading point of the compressor. The result of this design is optimized part-load performance far superior to single reciprocating compressors and step-only screw compressors.

### Simple Installation

- **Factory Testing Means Trouble-Free Start-Up.** All air-cooled Series R chillers are given a complete functional test at the factory. This computer-based test program completely checks the sensors, wiring, electrical components, microprocessor function,

communication capability, expansion valve performance and fans. In addition, each compressor is run tested to verify capacity and efficiency. Where applicable, each unit is factory preset to the customer's design conditions, an example would be leaving liquid temperature set point. The end result of this test program is that the chiller arrives at the job site fully tested and ready for operation.

- **Factory-Installed and -Tested Controls/Options Speed Installation.** All Series R chiller options, including main power supply disconnect, low ambient control, ambient temperature sensor, low ambient lockout, communication interface and ice making controls are factory installed and tested.

### Superior Control with the UCM-CLD Adaptive Control™ Microprocessor Module

#### System Options - Ice Storage

Trane air-cooled chillers are well suited for ice production. The unique ability to operate at decreased ambient temperature while producing ice lends to roughly the same work seen by the compressor. An air-cooled machine typically switches to ice production at night. Two things happen under this assumption. First, the leaving brine temperature from the evaporator is lowered to around  $-5.5$  to  $-5^{\circ}\text{C}$ . Second, the ambient temperature has typically dropped about  $8.3$  to  $11^{\circ}\text{C}$  from the peak daytime ambient. This effectively places a lift on the compressors that is similar to daytime running conditions. The chiller can operate in lower ambient at night and successfully produce ice to supplement the next day's cooling demands.

The Model RTAD produces ice by supplying ice storage tanks with a

constant supply of glycol solution. Air-cooled chillers selected for these lower leaving fluid temperatures are also selected for efficient production of chilled fluid at nominal comfort cooling conditions. The ability of Trane chillers to serve "double duty" in ice production and comfort cooling greatly reduces the capital cost of ice storage systems.

When cooling is required, ice chilled glycol is pumped from the ice storage tanks directly to the cooling coils. No expensive heat exchanger is required. The glycol loop is a sealed system, eliminating expensive annual chemical treatment costs. The air-cooled chiller is also available for comfort cooling duty at nominal cooling conditions and efficiencies. The modular concept of glycol ice storage systems and the proven simplicity of Trane Tracer™ controls allow the successful blend of reliability and energy saving performance in any ice storage application.

The ice storage system is operated in six different modes: each optimized for the utility cost of the hour.

1. Provide comfort cooling with chiller
2. Provide comfort cooling with ice
3. Provide comfort cooling with ice and chiller
4. Freeze ice storage
5. Freeze ice storage when comfort cooling is required
6. Off

Tracer optimization software controls operation of the required equipment and accessories to easily transition from one mode of operation to another. For example:

Even with ice storage systems there are numerous hours when ice is neither produced nor consumed, but saved. In this mode the chiller is the sole source of cooling. For example, to cool the building after all ice is produced but before high electrical demand charges take effect, Tracer sets the air-cooled chiller leaving fluid set point to its most efficient setting and starts the chiller, chiller

## Features and Benefits

---

pump, and load pump.

When electrical demand is high, the ice pump is started and the chiller is either demand limited or shut down completely. Tracer controls have the intelligence to optimally balance the contribution of ice and chiller in meeting the cooling load.

The capacity of the chiller plant is extended by operating the chiller and ice in tandem. Tracer rations the ice, augmenting chiller capacity while reducing cooling costs. When ice is produced, Tracer will lower the air-cooled chiller leaving fluid set point and start the chiller, ice and chiller pumps, and other accessories. Any incidental loads that persists while producing ice can be addressed by starting the load pump and drawing spent cooling fluid from the ice storage tanks.

For specific information on ice storage applications, contact your local Trane sales office.

# Features and Benefits

## Options

### High Efficiency/Performance Option

This option provides oversized heat exchangers with two purposes. One, it allows the unit to be more energy efficient. Two, the unit will have enhanced operation in high ambient conditions.

### Low Temperature Brine

The hardware and software on the unit are factory set to handle low temperature brine applications, typically below 5°C.

### Ice Making

The unit controls are factory set to handle ice making for thermal storage applications.

### Communication interface module

Provides the following possibilities:

1. Tracer/Summit Communication Interface Permits bi-directional communication to the Trane Integrated Comfort system.
2. Chilled Water Temperature Reset This option provides the control logic and field installed sensors to reset leaving chilled water temperature. The setpoint can be reset based off of either ambient temperature or return evaporator water temperature.
3. External Chilled Water Setpoint Allows the external setting independent of the front panel set point by mean of a 2-10VDC input or a 4-20mA input.
4. External Current Limit Setpoint Allows the external setting independent of the front panel set point by mean of a 2-10VDC input or a 4-20mA input.

### Hydraulic Module Option

(available on sizes RTAD 145SE - 180SE and RTAD 115HE - 145HE)

- Single or double pump (4 sizes each)
- Expansion vessel (50 l or 80l)
- Pressure relief valve set to 4 bar
- Water strainer (to be connected on job site)

- Thermally insulated evaporator and liquid line to reduce water condensing or freezing
- Contactors (option)

### Coil Protection

Rectangle punching type panels that protect the condenser coils on the two-third upper part only. The compressors and the evaporator are accessible.

### Service Valves

Provides a service valve on the discharge line of each circuit to facilitate compressor servicing.

### High Ambient Option

The high ambient option consists of special control logic to permit high ambient (46 °C) operation.

### Low Ambient Option

The low ambient option consists of special control logic and fans to permit low ambient (down to -18 °C) operation.

### Power Disconnect Switch

A disconnect switch plus compressor protection fuses with a through-the-door handle is provided to disconnect main power.

### Night Noise Set Back

At night, on a contact closure all the fans run at low speed bringing the overall sound level further down. Not available on high ambient units.

### Neoprene Isolators

Isolators provide isolation between chiller and structure to help eliminate vibration transmission. Neoprene isolators are more effective and recommended over spring isolators.

### Low Noise Version

The unit is equipped with low speed fans and compressors sound attenuating enclosure. All the sound emissive parts like refrigerant lines and panels subject to vibration are acoustically treated with sound

absorbent material.

### Ground Fault Detection

Sensing ground current for an improved chiller protection.

### Pressure Gauges

A set of two pressure gauges per refrigerant circuit, one for low pressure and one for high pressure.

### Counter Flanges

One set of mating flanges on which the customer will weld the pipe-work. (supplied with bolts and gaskets)

### Flow Switch

For field installation on the chilled water outlet connection.

### Under/Over-voltage protection

Controls the variation of the power supply voltage. If the value exceeds the minimum or maximum voltage, the unit is shut down.

### IP20 protection

Provides a protection against direct contacts inside the control panel. The current -carrying parts are shrouded in order to prevent accidental contact.



# Application Considerations

Certain application constraints should be considered when sizing, selecting and installing Trane air-cooled Series R chillers. Unit and system reliability is often dependent upon properly and completely complying with these considerations. When the application varies from the guidelines presented, it should be reviewed with your local Trane sales engineer.

### Unit Sizing

Intentionally over-sizing a unit to assure adequate capacity is not recommended. Erratic system operation and excessive compressor cycling are often a direct result of an over-sized chiller. In addition, an oversized unit is usually more expensive to purchase, install, and operate. If over-sizing is desired, consider using two units.

### Water Treatment

Dirt, scale, products of corrosion and other foreign material will adversely affect heat transfer between the water and system components. Foreign matter in the chilled water system can also increase pressure drop and, consequently, reduce water flow. Proper water treatment must be determined locally, depending on the type of system and local water characteristics. Neither salt nor brackish water is recommended for use in Trane air-cooled Series R chillers. Use of either will lead to a shortened life to an indeterminable degree. The Trane Company encourages the employment of a reputable water treatment specialist, familiar with local water conditions, to assist in this determination and in the establishment of a proper water treatment program.

### Effect Of Altitude on Capacity

At elevations substantially above sea level, the decreased air density will reduce condenser capacity and,

therefore, unit capacity and efficiency.

### Ambient Limitations

Trane air-cooled Series R chillers are designed for year-round operation over a range of ambient temperatures. The air-cooled Model RTAD chiller will operate in ambient temperatures of 7 to 40 °C. Selecting the high ambient option will allow the chiller to operate in ambient temperatures above 40 °C and selecting the low ambient option will increase the operational capability of the water chiller to ambient temperatures as low as -18 °C. For operation outside of these ranges, contact the local Trane sales office.

### Water Flow Limits

The minimum water flow rates are given in this catalog. Evaporator flow rates below the tabulated values will result in laminar flow causing freeze-up problems, scaling, stratification and poor control. The maximum evaporator water flow rate is also given in the general data section. Flow rates exceeding those listed may result in excessive tube erosion.

The evaporator can withstand up to 50 percent water flow reduction as

long as this flow is equal or above the minimum flow rate requirement. The microprocessor and capacity control algorithms are designed to take a minimum of 10% change in water flow rate per minute.

### Flow Rates out of Range

Many process cooling jobs require flow rates that cannot be met with the minimum and maximum published values within the Model RTAD evaporator. A simple piping change can alleviate this problem. For example: A plastic injection molding process requires 5.1 l/s of 10°C water and returns that water at 15.6°C. The selected chiller can operate at these temperatures, but has a minimum flow rate of 7.6 l/s. The following system can satisfy the process.

Figure 2 - Evaporator flow rate out of range

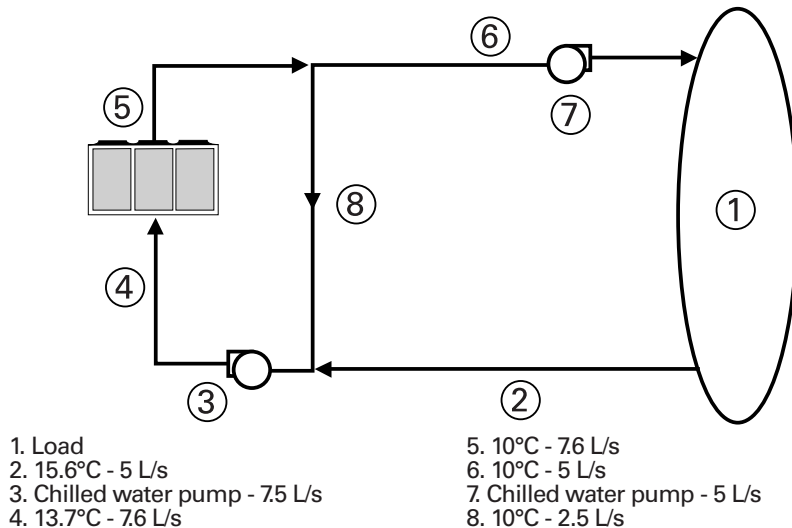



# Application Considerations

## Leaving Water Temperature Range.

Trane air-cooled Series R chillers have three distinct leaving water categories: standard, low temperature, and ice making. The standard leaving solution temperature range is 4.4 to 15.6 °C. Low temperature machines produce leaving liquid temperatures less than 4.4 °C. Since liquid supply temperature setpoints less than 4.4 °C result in suction temperatures at or below the freezing point of water, a glycol solution is required for all low temperature machines. Ice making machines have a leaving liquid temperature range of -6.7 to 15.6 °C. Ice making controls include dual set point controls and safeties for ice making and standard cooling capabilities. Consult your local Trane sales engineer for applications or selections involving low temperature or ice making machines. The maximum water temperature that can be circulated through an evaporator when the unit is not operating is 42 °C.

## Leaving Water Temperature out of Range

Similar to the flow rates above, many process cooling jobs require temperature ranges that cannot be met with the minimum and maximum published values for the Model RTAD evaporator. A simple piping change can alleviate this problem. For example: A laboratory load requires 7.6 l/s of water entering the process at 29.4°C and returning at 35°C. The accuracy required is better than cooling tower can give. The selected chiller has adequate capacity, but a maximum leaving chilled water temperature of 15°C.

In the example shown, both the chiller and process flow rates are equal. This is not necessary. For example, if the chiller had a higher flow rate, there would simply be more water bypassing and mixing with warm water.

## Supply Water Temperature Drop

The performance data for the Trane air-cooled Series R chiller is based on a chilled water temperature drop of 5°C. Chilled water temperature

drops from 3.3 to 10 °C may be used as long as minimum and maximum water temperature and minimum and maximum flow rates are not violated. Temperature drops outside this range are beyond the optimum range for control and may adversely affect the microcomputer's ability to maintain an acceptable supply water temperature range. Furthermore, temperature drops of less than 3.3 °C may result in inadequate refrigerant superheat. Sufficient superheat is always a primary concern in any direct expansion refrigerant system and is especially important in a package chiller where the evaporator is closely coupled to the compressor. When temperature drops are less than 3.3 °C, an evaporator runaround loop may be required.

## Ice Storage Provides Reduced Electrical Demand

An ice storage system uses a standard chiller to make ice at night when utilities charge less for electricity. The ice supplements or even replaces mechanical cooling during the day when utility rates are at their highest. This reduced need for cooling results in big utility cost savings.

Another advantage of ice storage is standby cooling capacity. If the chiller is unable to operate, one or two days of ice may still be available to provide cooling. In that time the chiller can be repaired before building occupants feel any loss of comfort.

The Trane Model RTAD chiller is uniquely suited to low temperature applications like ice storage because of the ambient relief experienced at night. This allows the Model RTAD chiller to produce ice efficiently, with less stress on the machine.

Simple and smart control strategies are another advantage the Model RTAD chiller offers for ice storage applications. Trane Tracer® building management systems can actually anticipate how much ice needs to be

Figure 3 - If temperatures are out of range for equipment

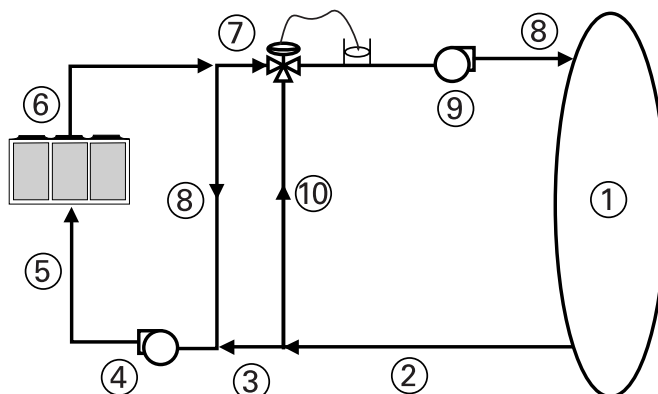

- |                       |                       |
|-----------------------|-----------------------|
| 1. Load               | 6. 15.6°C - 7.6 L/s   |
| 2. 35°C - 7.6 L/s     | 7. 15.6°C - 2.2 L/s   |
| 3. 35°C - 2.2 L/s     | 8. 15°C - 5.4 L/s     |
| 4. Chilled water pump | 9. Chilled water pump |
| 5. 21°C - 7.6 L/s     | 10. 35°C - 5.4 L/s    |

# Application Considerations

---

made at night and operate the system accordingly. The controls are integrated right into the chiller. Two wires and preprogrammed software dramatically reduce field installation cost and complex programming.

## **Short Water Loops**

The proper location of the temperature control sensor is in the supply (outlet) water connection or pipe. This location allows the building to act as a buffer and assures a slowly changing return water temperature. If there is not a sufficient volume of water in the system to provide an adequate buffer, temperature control can be lost, resulting in erratic system operation and excessive compressor cycling. A short water loop has the same effect as attempting to control from the building return water. Typically, a two-minute water loop is sufficient to prevent a short water loop. Therefore, as a guideline, ensure the volume of water in the evaporator loop equals or exceeds two times the evaporator flow rate. For a rapidly changing load profile, the amount of volume should be increased. To prevent the effect of a short water loop, the following items should be given careful consideration: A storage tank or larger header pipe to increase the volume of water in the system and, therefore, reduce the rate of change of the return water temperature.

## **Applications Types**

- Comfort cooling.
- Industrial process cooling.
- Ice/thermal storage.
- Low temperature process cooling.

# Selection Procedure

---

Chiller selections and performance information can be obtained through the use of the Series R® Chiller selection program.

## **Performance**

The computer selection program provides performance data for each chiller selection.

## **Dimensional Drawings**

The dimensional drawings illustrate overall measurements of the unit. Also shown are the service clearances required to easily service the RTAD chiller. All catalog dimensional drawings are subject to change. Current submittal drawings should be referred to for detailed dimensional information. Contact the sales office for submittal information.

## **Electrical Data Tables**

Compressor motor electrical data is shown in the data section for each compressor size. Rated load amperes (RLA), locked rotor Star-Delta amperes (LRA), the power factor for standard voltages for all 50 Hz, 3-phase motors are shown. The RLA is based on the performance of the motor developing full rated horsepower. A voltage utilization range is tabulated for each voltage listed.

## **Evaporator and Condenser Pressure Drop**

Pressure drop data is determined by the RTAD selection program.

# General Data

## SI Units

**Table G-1 - General Data RTAD Standard**

Size		85	100	115	125	145	150	165	180
Cooling capacity (5) (6)	kW	275.0	335.8	392.0	447.2	516.9	552.7	602.6	647.3
Power input (7)	kW	99.7	129.2	149.1	187.4	191.1	210.4	223.1	243.5
Energy Efficiency Ratio (5) (6) (as Eurovent)	kW/kW	2.76	2.60	2.63	2.39	2.71	2.63	2.70	2.66
ESEER (as Eurovent)	kW/kW	3.49	3.32	3.41	3.21	3.51	3.33	3.40	3.27
IPLV (According to ARI conditions 44°F leaving water temperature, 95°C entering air temperature)	kW/kW	3.94	3.72	3.86	3.67	3.94	3.75	3.77	3.68
<b>Compressor</b>									
Quantity		2	2	2	2	2	2	2	2
Nominal Size (1)	tons	40/40	50/50	60/60	70/70	85/70	85/85	100/85	100/100
<b>Evaporator</b>									
Evaporator Model		EG120	EG140	EG170	EG200	EG200	EG200	EG250	EG250
Water Storage	l	106	270	222	204	204	204	415	415
Minimum Flow	l/s	4.1	6.0	7.3	8.8	8.8	8.8	11.6	11.6
Maximum Flow	l/s	17.3	20.8	24.6	30.7	30.7	30.7	38.0	38.0
<b>Condenser</b>									
Qty of Coils		2	2	2	2	2	2	2	2
Coil Length	mm	2743	3658	3658	3658	4572	4572	5486	5486
Coil Height	mm	1626	1626	1626	1626	1626	1626	1626	1626
Fin series	fins/ft	192	192	192	192	192	192	192	192
Number of Rows		3/3	2/2	3/3	3/3	3/3	3/3	3/3	3/3
<b>Condenser Fans</b>									
Quantity (1)		3/3	3/3	3/3	3/3	5/4	5/5	6/5	6/6
Diameter	mm	762	762	762	762	762	762	762	762
Total Air Flow	m <sup>3</sup> /s	23.52	28.09	26.71	26.73	36.99	39.24	44.89	47.08
Nominal RPM		915	915	915	915	915	915	915	915
Tip Speed	m/s	37.1	37.1	37.1	37.1	37.1	37.1	37.1	37.1
Motor kW	kW	2.05	2.05	2.05	2.05	2.05	2.05	2.05	2.05
<b>Minimum Starting/Oper Ambient(2)</b>									
Standard Unit	°C	0	0	0	0	0	0	0	0
Low Ambient Unit	°C	-18	-18	-18	-18	-18	-18	-18	-18
<b>General Unit</b>									
Refrigerant		HFC 134a	HFC 134a	HFC 134a	HFC 134a	HFC 134a	HFC 134a	HFC 134a	HFC 134a
No. Of independent Refrigerant Circuits		2	2	2	2	2	2	2	2
% Minimum Load (3)		17	17	17	17	17	17	17	17
Operating Weight (4)	kg	2760	3205	3655	3670	4260	4520	5440	5525
Shipping Weight (4)	kg	2660	2940	3440	3470	4060	4320	5030	5115

**Notes:**

- (1) Data containing information on two circuits shown as follows: ckt1/ckt2
- (2) Minimum start-up/operation ambient based on a 2.22 m/s (5mph) wind across the condenser.
- (3) Percent minimum load is for total machine at 10°C (50°F) ambient and 7°C (44°F) leaving chilled water temperature, not each individual circuit.
- (4) With aluminium fins.
- (5) At Eurovent conditions, 7°C leaving water temperature and 35°C entering condenser air temperature.
- (6) Ratings based on sea level altitude and evaporator fouling factor or 0.017615 m<sup>2</sup>°K/kW
- (7) Unit kW input, including fans

# General Data

**Table G-2 - General Data RTAD High Efficiency**

Size		85	100	115	125	145	150
Cooling capacity (5) (6)	kW	297.5	360.4	418.1	489.8	524.6	562.9
Power input (7)	kW	95.9	122.2	144.2	176.1	182.9	201.6
Energy Efficiency Ratio (5) (6) (as Eurovent)	kW/kW	3.10	2.95	2.90	2.78	2.87	2.79
ESEER (as Eurovent)	kW/kW	3.92	3.63	3.59	3.45	3.59	3.41
IPLV (According to ARI conditions 44°F leaving water temperature, 95°C entering air temperature)	kW/kW	4.40	4.08	4.04	3.91	4.00	3.82
<b>Compressor</b>							
Quantity		2	2	2	2	2	2
Nominal Size (1)	tons	40/40	50/50	60/60	70/70	85/70	85/85
<b>Evaporator</b>							
Evaporator Model		EG140	EG170	EG200	EG200	EG250	EG250
Water Storage	l	270	222	204	204	415	415
Minimum Flow	l/s	6.0	7.3	8.8	8.8	11.6	11.6
Maximum Flow	l/s	20.8	24.6	30.7	30.7	38	38
<b>Condenser</b>							
Qty of Coils		2	2	2	2	2	2
Coil Length	mm	3658	3658	4572	4572	5486	5486
Coil Height	mm	1626	1626	1626	1626	1626	1626
Fin series	fins/ft	192	192	192	192	192	192
Number of Rows		3/3	3/3	3/3	3/3	3/3	3/3
<b>Condenser Fans</b>							
Quantity (1)		3/3	4/4	4/4	5/5	6/5	6/6
Diameter	mm	762	762	762	762	762	762
Total Air Flow	m <sup>3</sup> /s	26,67	31,35	34,71	39,21	44,85	47,04
Nominal RPM		915	915	915	915	915	915
Tip Speed	m/s	37.1	37.1	37.1	37.1	37.1	37.1
Motor kW	kW	2.05	2.05	2.05	2.05	2.05	2.05
<b>Minimum Starting/Oper Ambient(2)</b>							
Standard Unit	°C	0	0	0	0	0	0
Low Ambient Unit	°C	-18	-18	-18	-18	-18	-18
<b>General Unit</b>							
Refrigerant		HFC 134a	HFC 134a	HFC 134a	HFC 134a	HFC 134a	HFC 134a
Refrigerant Circuits		2	2	2	2	2	2
% Minimum Load (3)		17	17	17	17	17	17
Operating Weight (4)	kg	3340	3470	4005	4100	5390	5445
Shipping Weight (4)	kg	3075	3145	3800	3900	4980	5035

**Notes:**

- (1) Data containing information on two circuits shown as follows: ckt1/ckt2
- (2) Minimum start-up/operation ambient based on a 2.22 m/s (5mph) wind across the condenser.
- (3) Percent minimum load is for total machine at 10°C (50°F) ambient and 7°C (44°F) leaving chilled water temperature, not each individual circuit.
- (4) With aluminium fins.
- (5) At Eurovent conditions, 7°C leaving water temperature and 35°C entering condenser air temperature.
- (6) Ratings based on sea level altitude and evaporator fouling factor of 0.017615 m<sup>2</sup>K/kW
- (7) Unit kW input, including fans

# General Data

**Table G-3 - General Data RTAD Standard Low Noise**

Size		85	100	115	125	145	150	165	180
Cooling capacity (5) (6)	kW	267.9	324.5	375.9	423.3	501.4	535.5	587.2	630.4
Power input (7)	kW	100.7	131.2	154.7	197.5	196.7	216.5	228.4	249.5
Energy Efficiency Ratio (5) (6) (as Eurovent)	kW/kW	2.66	2.48	2.43	2.14	2.55	2.48	2.57	2.53
ESEER (as Eurovent)	kW/kW	3.54	3.31	3.31	3.05	3.45	3.30	3.38	3.24
IPLV (According to ARI conditions 44°F leaving water temperature, 95°C entering air temperature)	kW/kW	4.01	3.75	3.79	3.52	3.91	3.75	3.79	3.67
<b>Compressor</b>									
Quantity		2	2	2	2	2	2	2	2
Nominal Size (1)	tons	40/40	50/50	60/60	70/70	85/70	85/85	100/85	100/100
<b>Evaporator</b>									
Evaporator Model		EG120	EG140	EG170	EG200	EG200	EG200	EG250	EG250
Water Storage	l	106	270	222	204	204	204	415	415
Minimum Flow	l/s	4.1	6.0	7.3	8.8	8.8	8.8	11.6	11.6
Maximum Flow	l/s	17.3	20.8	24.6	30.7	30.7	30.7	38	38
<b>Condenser</b>									
Qty of Coils		2	2	2	2	2	2	2	2
Coil Length	mm	2743	3658	3658	3658	4572	4572	5486	5486
Coil Height	mm	1626	1626	1626	1626	1626	1626	1626	1626
Fin series	Fins/ft	192	192	192	192	192	192	192	192
Number of Rows		3/3	2/2	3/3	3/3	3/3	3/3	3/3	3/3
<b>Condenser Fans</b>									
Quantity (1)		3/3	3/3	3/3	3/3	5/4	5/5	6/5	6/6
Diameter	mm	762	762	762	762	762	762	762	762
Total Air Flow	m <sup>3</sup> /s	19.22	23.11	21.91	21.93	30.28	32.08	36.74	38.49
Nominal RPM		730	730	730	730	730	730	730	730
Tip Speed	m/s	29.9	29.9	29.9	29.9	29.9	29.9	29.9	29.9
Motor kW	kW	1.30	1.30	1.30	1.30	1.30	1.30	1.30	1.30
<b>Minimum Starting/Oper Ambient(2)</b>									
Standard Unit	°C	0	0	0	0	0	0	0	0
Low Ambient Unit	°C	-18	-18	-18	-18	-18	-18	-18	-18
<b>General Unit</b>									
Refrigerant		HFC 134a	HFC 134a	HFC 134a	HFC 134a	HFC 134a	HFC 134a	HFC 134a	HFC 134a
No. Of independent Refrigerant Circuits		2	2	2	2	2	2	2	2
% Minimum Load (3)		17	17	17	17	17	17	17	17
Operating Weight (4)	kg	2760	3205	3655	3670	4360	4620	5540	5625
Shipping Weight (4)	kg	2660	2940	3440	3470	4160	4420	5130	5215

**Notes:**

- (1) Data containing information on two circuits shown as follows: ckt1/ckt2
- (2) Minimum start-up/operation ambient based on a 2.22 m/s (5mph) wind across the condenser.
- (3) Percent minimum load is for total machine at 10°C (50°F) ambient and 7°C (44°F) leaving chilled water temperature, not each individual circuit.
- (4) With aluminium fins.
- (5) At Eurovent conditions, 7°C leaving water temperature and 35°C entering condenser air temperature.
- (6) Ratings based on sea level altitude and evaporator fouling factor or 0.017615 m<sup>2</sup>°K/kW
- (7) Unit kW input, including fans

# General Data

**Table G-4 - General Data RTAD High Efficiency Low Noise**

Size		85	100	115	125	145	150
Cooling capacity (5) (6)	kW	290.4	351.3	408.9	478.2	514.4	551.3
Power input (7)	kW	96.1	122.4	146.5	179.1	184.5	203.6
Energy Efficiency Ratio (5) (6) (as Eurovent)	kW/kW	3.02	2.87	2.79	2.67	2.79	2.71
ESEER (as Eurovent)	kW/kW	4.01	3.71	3.61	3.47	3.64	3.45
IPLV (According to ARI conditions 44°F leaving water temperature, 95°C entering air temperature)	kW/kW	4.53	4.21	4.07	3.95	4.07	3.89
<b>Compressor</b>							
Quantity		2	2	2	2	2	2
Nominal Size (1)	tons	40/40	50/50	60/60	70/70	85/70	85/85
<b>Evaporator</b>							
Evaporator Model		EG140	EG170	EG200	EG200	EG250	EG250
Water Storage	l	270	222	204	204	415	415
Minimum Flow	l/s	6.0	7.3	8.8	8.8	11.6	11.6
Maximum Flow	l/s	20.8	24.6	30.7	30.7	38	38
<b>Condenser</b>							
Qty of Coils		2	2	2	2	2	2
Coil Length	mm	3658	3658	4572	4572	5486	5486
Coil Height	mm	1626	1626	1626	1626	1626	1626
Fin series	fins/ft	192	192	192	192	192	192
Number of Rows		3/3	3/3	3/3	3/3	3/3	3/3
<b>Condenser Fans</b>							
Quantity (1)		3/3	4/4	4/4	5/5	6/5	6/6
Diameter	mm	762	762	762	762	762	762
Total Air Flow	m <sup>3</sup> /s	21.88	25.62	28.45	32.05	36.7	38.45
Nominal RPM		690	690	690	690	690	690
Tip Speed	m/s	29.9	29.9	29.9	29.9	29.9	29.9
Motor kW	kW	1.30	1.30	1.30	1.30	1.30	1.30
<b>Minimum Starting/Oper Ambient(2)</b>							
Standard Unit	°C	0	0	0	0	0	0
Low Ambient Unit	°C	-18	-18	-18	-18	-18	-18
<b>General Unit</b>							
Refrigerant		HFC 134a	HFC 134a	HFC 134a	HFC 134a	HFC 134a	HFC 134a
No. Of independent Refrigerant Circuits		2	2	2	2	2	2
% Minimum Load (3)		17	17	17	17	17	17
Operating Weight (4)	kg	3340	3570	4005	4100	5490	5545
Shipping Weight (4)	kg	3075	3245	3800	3900	5080	5135

**Notes:**

- (1) Data containing information on two circuits shown as follows: ckt1/ckt2
- (2) Minimum start-up/operation ambient based on a 2.22 m/s (5mph) wind across the condenser.
- (3) Percent minimum load is for total machine at 10°C (50°F) ambient and 7°C (44°F) leaving chilled water temperature, not each individual circuit.
- (4) With aluminium fins.
- (5) At Eurovent conditions, 7°C leaving water temperature and 35°C entering condenser air temperature.
- (6) Ratings based on sea level altitude and evaporator fouling factor of 0.017615 m<sup>2</sup>K/kW
- (7) Unit kW input, including fans



# General Data

**Table G-5 - General Data RTAD Standard Low Noise with Night Noise Set Back option**

Size		85	100	115	125	145	150	165	180
Cooling capacity (5) (6)	kW	251.0	318.9	366.4	398.0	483.1	508.4	569.6	605.5
Power input (7)	kW	109.4	133.3	159.4	194.5	207	231.8	238.7	264.3
Energy Efficiency Ratio (5) (6) (as Eurovent)	kW/kW	2.30	2.39	2.30	2.05	2.34	2.20	2.39	2.29
ESEER (as Eurovent)	kW/kW	3.28	3.26	3.20	2.93	3.32	3.07	3.26	3.05
IPLV (According to ARI conditions 44°F leaving water temperature, 95°C entering air temperature)	kW/kW	3.76	3.70	3.69	3.41	3.78	3.52	3.69	3.50
<b>Compressor</b>									
Quantity		2	2	2	2	2	2	2	2
Nominal Size (1)	tons	40/40	50/50	60/60	70/70	85/70	85/85	100/85	100/100
<b>Evaporator</b>									
Evaporator Model		EG120	EG140	EG170	EG200	EG200	EG200	EG250	EG250
Water Storage	l	106	270	222	204	204	204	415	415
Minimum Flow	l/s	4.1	6.0	7.3	8.8	8.8	8.8	11.6	11.6
Maximum Flow	l/s	17.3	20.8	24.6	30.7	30.7	30.7	38	38
<b>Condenser</b>									
Qty of Coils		2	2	2	2	2	2	2	2
Coil Length	mm	2743	3658	3658	3658	4572	4572	5486	5486
Coil Height	mm	1626	1626	1626	1626	1626	1626	1626	1626
Fin series	fins/ft	192	192	192	192	192	192	192	192
Number of Rows		3/3	2/2	3/3	3/3	3/3	3/3	3/3	3/3
<b>Condenser Fans</b>									
Quantity (1)		2/2	3/3	3/3	3/3	4/4	4/4	5/5	5/5
Diameter	mm	762	762	762	762	762	762	762	762
Total Air Flow	m <sup>3</sup> /s	13.97	21.28	19.94	19.96	25.78	25.79	31.55	31.57
Nominal RPM		550	550	550	550	550	550	550	550
Tip Speed	m/s	28.1	28.1	28.1	28.1	28.1	28.1	28.1	28.1
Motor kW	kW	1.05	1.05	1.05	1.05	1.05	1.05	1.05	1.05
<b>Minimum Starting/Oper Ambient(2)</b>									
Standard Unit	°C	0	0	0	0	0	0	0	0
Low Ambient Unit	°C	-18	-18	-18	-18	-18	-18	-18	-18
<b>General Unit</b>									
Refrigerant		HFC 134a	HFC 134a	HFC 134a	HFC 134a	HFC 134a	HFC 134a	HFC 134a	HFC 134a
No. Of independent Refrigerant Circuits		2	2	2	2	2	2	2	2
% Minimum Load (3)		17	17	17	17	17	17	17	17
Operating Weight (4)	kg	2670	3205	3655	3670	4360	4620	5540	5625
Shipping Weight (4)	kg	2560	2940	3440	3470	4160	4420	5130	5215

**Notes:**

- (1) Data containing information on two circuits shown as follows: ckt1/ckt2
- (2) Minimum start-up/operation ambient based on a 2.22 m/s (5mph) wind across the condenser.
- (3) Percent minimum load is for total machine at 10°C (50°F) ambient and 7°C (44°F) leaving chilled water temperature, not each individual circuit.
- (4) With aluminium fins.
- (5) At Eurovent conditions, 7°C leaving water temperature and 35°C entering condenser air temperature.
- (6) Ratings based on sea level altitude and evaporator fouling factor or 0.017615 m<sup>2</sup>°K/kW
- (7) Unit kW input, including fans

# General Data

**Table G-6 - General Data RTAD High Efficiency Low Noise with Night Noise Set Back option**

Size		85	100	115	125	145	150
Cooling capacity (5) (6)	kW	285.9	334.4	402.9	459.2	502.8	534.1
Power input (7)	kW	97.5	128.6	150	189.6	191.0	213.0
Energy Efficiency Ratio (5) (6) (as Eurovent)	kW/kW	2.93	2.60	2.69	2.42	2.63	2.51
ESEER (as Eurovent)	kW/kW	3.96	3.54	3.53	3.29	3.55	3.32
IPLV (According to ARI conditions 44°F leaving water temperature, 95°C entering air temperature)	kW/kW	4.49	4.05	4.00	3.76	3.99	3.77
<b>Compressor</b>							
Quantity		2	2	2	2	2	2
Nominal Size (1)	tons	40/40	50/50	60/60	70/70	85/70	85/85
<b>Evaporator</b>							
Evaporator Model		EG140	EG170	EG200	EG200	EG250	EG250
Water Storage	l	270	222	204	204	415	415
Minimum Flow	l/s	6.0	7.3	8.8	8.8	11.6	11.6
Maximum Flow	l/s	20.8	24.6	30.7	30.7	38	38
<b>Condenser</b>							
Qty of Coils		2	2	2	2	2	2
Coil Length	mm	3658	3658	4572	4572	5486	5486
Coil Height	mm	1626	1626	1626	1626	1626	1626
Fin series	fins/ft	192	192	192	192	192	192
Number of Rows		3/3	3/3	3/3	3/3	3/3	3/3
<b>Condenser Fans</b>							
Quantity (1)		3/3	3/3	4/4	4/4	5/5	5/5
Diameter	mm	762	762	762	762	762	762
Total Air Flow	m <sup>3</sup> /s	19.89	19.92	25.73	25.76	31.51	31.53
Nominal RPM		550	550	550	550	550	550
Tip Speed	m/s	28.1	28.1	28.1	28.1	28.1	28.1
Motor kW	kW	1.05	1.05	1.05	1.05	1.05	1.05
<b>Minimum Starting/Oper Ambient(2)</b>							
Standard Unit	°C	0	0	0	0	0	0
Low Ambient Unit	°C	-18	-18	-18	-18	-18	-18
<b>General Unit</b>							
Refrigerant		HFC 134a	HFC 134a	HFC 134a	HFC 134a	HFC 134a	HFC 134a
No. Of independent Refrigerant Circuits		2	2	2	2	2	2
% Minimum Load (3)		17	17	17	17	17	17
Operating Weight	kg	3440	3570	4005	4115	5490	5545
Shipping Weight	kg	3175	3245	3800	3915	5080	5135

**Notes:**

- (1) Data containing information on two circuits shown as follows: ckt1/ckt2
- (2) Minimum start-up/operation ambient based on a 2.22 m/s (5mph) wind across the condenser.
- (3) Percent minimum load is for total machine at 10°C (50°F) ambient and 7°C (44°F) leaving chilled water temperature, not each individual circuit.
- (4) With aluminium fins.
- (5) At Eurovent conditions, 7°C leaving water temperature and 35°C entering condenser air temperature.
- (6) Ratings based on sea level altitude and evaporator fouling factor of 0.017615 m<sup>2</sup>°K/kW
- (7) Unit kW input, including fans

# General Data

**Table G-7 - General Data RTAD Standard High External Static Pressure**

Size		85	100	115	125	145	150	165	180
Cooling capacity (5) (6)	kW	264.4	317.5	366.0	397.7	492.2	526.7	577.7	621.3
Power input (7)	kW	113.3	145.1	170.4	205.4	217.6	238.9	253.2	275.9
Energy Efficiency Ratio (5) (6) (as Eurovent)	kW/kW	2.33	2.19	2.15	1.94	2.26	2.21	2.28	2.25
ESEER (as Eurovent)	kW/kW	2.91	2.80	2.83	2.65	2.94	2.80	2.86	2.76
IPLV (According to ARI conditions 44°F leaving water temperature, 95°C entering air temperature)	kW/kW	3.25	3.17	3.23	3.06	3.31	3.16	3.21	3.11
<b>Compressor</b>									
Quantity		2	2	2	2	2	2	2	2
Nominal Size (1)	tons	40/40	50/50	60/60	70/70	85/70	85/85	100/85	100/100
<b>Evaporator</b>									
Evaporator Model		EG120	EG140	EG170	EG200	EG200	EG200	EG250	EG250
Water Storage	l	106	270	222	204	204	204	415	415
Minimum Flow	l/s	4.1	6.0	7.3	8.8	8.8	8.8	11.6	11.6
Maximum Flow	l/s	17.3	20.8	24.6	30.7	30.7	30.7	38	38
<b>Condenser</b>									
Qty of Coils		2	2	2	2	2	2	2	2
Coil Length	mm	2743	3658	3658	3658	4572	4572	5486	5486
Coil Height	mm	1626	1626	1626	1626	1626	1626	1626	1626
Fin series	Fins/ft	192	192	192	192	192	192	192	192
<b>Number of Rows</b>									
Condenser Fans		3/3	2/2	3/3	3/3	3/3	3/3	3/3	3/3
Quantity (1)		3/3	3/3	3/3	3/3	5/4	5/5	6/5	6/6
Diameter	mm	762	762	762	762	762	762	762	762
Total Air Flow	m <sup>3</sup> /s	18.46	21.53	20.4	20.35	28.67	30.69	34.86	36.84
Nominal RPM		935	935	935	935	935	935	935	935
Tip Speed	m/s	37.3	37.3	37.3	37.3	37.3	37.3	37.3	37.3
Motor kW	kW	1.05	2.05	3.05	4.05	5.05	6.05	7.05	8.05
<b>Min Starting/Oper Ambient(2)</b>									
Standard Unit	°C	0	0	0	0	0	0	0	0
Low Ambient Unit	°C	-18	-18	-18	-18	-18	-18	-18	-18
<b>General Unit</b>									
Refrigerant		R134a	R134a	R134a	R134a	R134a	R134a	R134a	R134a
No. Of independent Refrigerant Circuits		2	2	2	2	2	2	2	2
% Min. Load (3)		17	17	17	17	17	17	17	17
Operating Weight (4)	kg	2760	3205	3655	3670	4260	4520	5440	5525
Shipping Weight (4)	kg	2660	2940	3440	3470	4060	4320	5030	5115

**Notes:**

- (1) Data containing information on two circuits shown as follows: ckt1/ckt2
- (2) Minimum start-up/operation ambient based on a 2.22 m/s (5mph) wind across the condenser.
- (3) Percent minimum load is for total machine at 10°C (50°F) ambient and 7°C (44°F) leaving chilled water temperature, not each individual circuit.
- (4) With aluminium fins.
- (5) At Eurovent conditions, 7°C leaving water temperature and 35°C entering condenser air temperature.
- (6) Ratings based on sea level altitude and evaporator fouling factor of 0.017615 m<sup>2</sup>K/kW
- (7) Unit kW input, including fans

# General Data

**Table G-8 - General Data RTAD High Efficiency High External Static Pressure**

Size		85	100	115	125	145	150
Cooling capacity (5) (6)	kW	285.5	346.3	402.6	471.5	507.7	544.3
Power input (7)	kW	108.8	138.7	164.4	200.4	207.8	228.6
Energy Efficiency Ratio (5) (6) (as Eurovent)	kW/kW	2.62	2.50	2.45	2.36	2.45	2.38
ESEER (as Eurovent)	kW/kW	3.25	3.02	3.00	2.89	3.02	2.87
IPLV (According to ARI conditions 44°F leaving water temperature, 95°C entering air temperature)	kW/kW	3.67	3.42	3.35	3.24	3.36	3.19
<b>Compressor</b>							
Quantity		2	2	2	2	2	2
Nominal Size (1)	tons	40/40	50/50	60/60	70/70	85/70	85/85
<b>Evaporator</b>							
Evaporator Model		EG140	EG170	EG200	EG200	EG250	EG250
Water Storage	l	270	222	204	204	415	415
Minimum Flow	l/s	6.0	7.3	8.8	8.8	11.6	11.6
Maximum Flow	l/s	20.8	24.6	30.7	30.7	38	38
<b>Condenser</b>							
Qty of Coils		2	2	2	2	2	2
Coil Length	mm	3658	3658	4572	4572	5486	5486
Coil Height	mm	1626	1626	1626	1626	1626	1626
Fin series	fins/ft	192	192	192	192	192	192
Number of Rows		3/3	3/3	3/3	3/3	3/3	3/3
<b>Condenser Fans</b>							
Quantity (1)		3/3	4/4	4/4	5/5	6/5	6/6
Diameter	mm	762	762	762	762	762	762
Total Air Flow	m <sup>3</sup> /s	20.5	24.62	26.71	30.74	34.92	36.91
Nominal RPM		935	935	935	935	935	935
Tip Speed	m/s	37.3	37.3	37.3	37.3	37.3	37.3
Motor kW	kW	1.05	2.05	3.05	4.05	5.05	6.05
<b>Minimum Starting/Oper Ambient(2)</b>							
Standard Unit	°C	0	0	0	0	0	0
Low Ambient Unit	°C	-18	-18	-18	-18	-18	-18
<b>General Unit</b>							
Refrigerant		R134a	R134a	R134a	R134a	R134a	R134a
No. Of independent Refrigerant Circuits		2	2	2	2	2	2
% Minimum Load (3)		17	17	17	17	17	17
Operating Weight (4)	kg	3340	3470	4005	4100	5390	5445
Shipping Weight (4)	kg	3075	3145	3800	3900	4980	5035

**Notes:**

- (1) Data containing information on two circuits shown as follows: ckt1/ckt2
- (2) Minimum start-up/operation ambient based on a 2.22 m/s (5mph) wind across the condenser.
- (3) Percent minimum load is for total machine at 10°C (50°F) ambient and 7°C (44°F) leaving chilled water temperature, not each individual circuit.
- (4) With aluminium fins.
- (5) At Eurovent conditions, 7°C leaving water temperature and 35°C entering condenser air temperature.
- (6) Ratings based on sea level altitude and evaporator fouling factor or 0.017615 m<sup>2</sup>K/kW
- (7) Unit kW input, including fans

# General Data

## English Units

**Table G-9- General Data RTAD Standard**

Size		85	100	115	125	145	150	165	180
Cooling capacity (5) (6)	tons	78.2	95.5	111.5	127.2	147.0	157.2	171.4	184.1
Power input (7)	kW	99.7	129.2	149.1	187.4	191.1	210.4	223.1	243.5
Energy Efficiency Ratio (5) (6) (as Eurovent)	MBH/kW	9.42	8.87	8.97	8.15	9.25	8.97	9.21	9.08
ESEER (as Eurovent)	MBH/kW	11.91	11.33	11.63	10.95	11.98	11.36	11.60	11.16
IPLV (According to ARI conditions 44°F leaving water temperature, 95°C entering air temperature)	MBH/kW	13.44	12.69	13.17	12.52	13.44	12.80	12.86	12.56
<b>Compressor</b>									
Quantity		2	2	2	2	2	2	2	2
Nominal Size (1)	tons	40/40	50/50	60/60	70/70	85/70	85/85	100/85	100/100
<b>Evaporator</b>									
Evaporator Model		EG120	EG140	EG170	EG200	EG200	EG200	EG250	EG250
Water Storage	gallon	28.0	71.3	58.6	53.9	53.9	53.9	109.6	109.6
Minimum Flow	gpm	65.0	95.1	115.7	139.5	139.5	139.5	183.9	183.9
Maximum Flow	gpm	274.2	329.7	389.9	486.6	486.6	486.6	602.3	602.3
<b>Condenser</b>									
Qty of Coils		2	2	2	2	2	2	2	2
Coil Length	ft	108.0	144.0	144.0	144.0	180.0	180.0	216.0	216.0
Coil Height	ft	64.0	64.0	64.0	64.0	64.0	64.0	64.0	64.0
Fin series	fins/ft	192	192	192	192	192	192	192	192
Number of Rows		3/3	2/2	3/3	3/3	3/3	3/3	3/3	3/3
<b>Condenser Fans</b>									
Quantity (1)		3/3	3/3	3/3	3/3	5/4	5/5	6/5	6/6
Diameter	ft	30	30	30	30	30	30	30	30
Total Air Flow	cfm	49836	59519	56595	56638	78377	83145	95117	99757
Nominal RPM		915	915	915	915	915	915	915	915
Tip Speed	ft/s	122	122	122	122	122	122	122	122
Motor kW	kW	1.57	1.57	1.57	1.57	1.57	1.57	1.57	1.57
<b>Minimum Starting/Oper Ambient(2)</b>									
Standard Unit	°F	32	32	32	32	32	32	32	32
Low Ambient Unit	°F	0	0	0	0	0	0	0	0
<b>General Unit</b>									
Refrigerant		HFC 134a	HFC 134a	HFC 134a	HFC 134a	HFC 134a	HFC 134a	HFC 134a	HFC 134a
No. Of independent Refrigerant Circuits		2	2	2	2	2	2	2	2
% Minimum Load (3)		17	17	17	17	17	17	17	17
Operating Weight (4)	lb	6085	7066	8058	8091	9392	9965	11993	12181
Shipping Weight (4)	lb	5864	6482	7584	7650	8951	9524	11089	11277

**Notes:**

- (1) Data containing information on two circuits shown as follows: ckt1/ckt2
- (2) Minimum start-up/operation ambient based on a 2.22 m/s (5mph) wind across the condenser.
- (3) Percent minimum load is for total machine at 10°C (50°F) ambient and 7°C (44°F) leaving chilled water temperature, not each individual circuit.
- (4) With aluminium fins.
- (5) At Eurovent conditions, 7°C leaving water temperature and 35°C entering condenser air temperature.
- (6) Ratings based on sea level altitude and evaporator fouling factor or 0.017615 m<sup>2</sup>°K/kW
- (7) Unit kW input, including fans

# General Data

**Table G-10 - General Data RTAD High Efficiency**

Size		85	100	115	125	145	150
Cooling capacity (5) (6)	tons	84.6	102.5	118.9	139.3	149.2	160.1
Power input (7)	kW	95.9	122.2	144.2	176.1	182.9	201.6
Energy Efficiency Ratio (5) (6)							
(as Eurovent)	MBH/kW	10.58	10.07	9.89	9.49	9.79	9.52
ESEER (as Eurovent)	MBH/kW	13.38	12.39	12.25	11.77	12.25	11.63
IPLV (According to ARI conditions 44°F leaving water temperature, 95°C entering air temperature)	MBH/kW	15.01	13.92	13.78	13.34	13.65	13.03
<b>Compressor</b>							
Quantity		2	2	2	2	2	2
Nominal Size (1)	tons	40/40	50/50	60/60	70/70	85/70	85/85
<b>Evaporator</b>							
Evpaporator Model		EG140	EG170	EG200	EG200	EG250	EG250
Water Storage	gal.	71.3	58.6	53.9	53.9	109.6	109.6
Minimum Flow	gpm	95.1	115.7	139.5	139.5	183.9	183.9
Maximum Flow	gpm	329.7	389.9	486.6	486.6	602.3	602.3
<b>Condenser</b>							
Qty of Coils		2	2	2	2	2	2
Coil Length	ft	144.0	144.0	180.0	180.0	216.0	216.0
Coil Height	ft	64.0	64.0	64.0	64.0	64.0	64.0
Fin series	fins/ft	192	192	192	192	192	192
Number of Rows		3/3	3/3	3/3	3/3	3/3	3/3
<b>Condenser Fans</b>							
Quantity (1)		3/3	4/4	4/4	5/5	6/5	6/6
Diameter	ft	30	30	30	30	30	30
Total Air Flow	cfm	56511	66427	73546	83081	95032	99672
Nominal RPM		915	915	915	915	915	915
Tip Speed	ft/s	122	122	122	122	122	122
Motor kW	kW	1.57	1.57	1.57	1.57	1.57	1.57
<b>Minimum Starting/Oper Ambient(2)</b>							
Standard Unit	°F	32	32	32	32	32	32
Low Ambient Unit	°F	0	0	0	0	0	0
<b>General Unit</b>							
Refrigerant		HFC 134a	HFC 134a	HFC 134a	HFC 134a	HFC 134a	HFC 134a
No. Of independent Refrigerant Circuits		2	2	2	2	2	2
% Minimum Load (3)		17	17	17	17	17	17
Operating Weight (4)	lb	7363	7650	8830	9039	11883	12004
Shipping Weight (4)	lb	6779	6934	8378	8598	10979	11100

**Notes:**

- (1) Data containing information on two circuits shown as follows: ckt1/ckt2
- (2) Minimum start-up/operation ambient based on a 2.22 m/s (5mph) wind across the condenser.
- (3) Percent minimum load is for total machine at 10°C (50°F) ambient and 7°C (44°F) leaving chilled water temperature, not each individual circuit.
- (4) With aluminium fins.
- (5) At Eurovent conditions, 7°C leaving water temperature and 35°C entering condenser air temperature.
- (6) Ratings based on sea level altitude and evaporator fouling factor or 0.017615 m<sup>2</sup>/K/kW
- (7) Unit kW input, including fans

# General Data

**Table G-11 - General Data RTAD High Efficiency Low Noise**

Size		85	100	115	125	145	150	165	180
Cooling capacity (5) (6)	tons	76.2	92.3	106.9	120.4	142.6	152.3	167.0	179.3
Power input (7)	kW	100.7	131.2	154.7	197.5	196.7	216.5	228.4	249.5
Energy Efficiency Ratio (5) (6) (as Eurovent)	MBH/kW	9.08	8.46	8.29	7.30	8.70	8.46	8.77	8.63
ESEER (as Eurovent)	MBH/kW	12.08	11.29	11.29	10.41	11.77	11.26	11.53	11.05
IPLV (According to ARI conditions 44°F leaving water temperature, 95°C entering air temperature)	MBH/kW	13.68	12.80	12.93	12.01	13.34	12.80	12.93	12.52
<b>Compressor</b>									
Quantity		2	2	2	2	2	2	2	2
Nominal Size (1)	tons	40/40	50/50	60/60	70/70	85/70	85/85	100/85	100/100
<b>Evaporator</b>									
Evaporator Model		EG120	EG140	EG170	EG200	EG200	EG200	EG250	EG250
Water Storage	gal.	28.0	71.3	58.6	53.9	53.9	53.9	109.6	109.6
Minimum Flow	gpm	65.0	95.1	115.7	139.5	139.5	139.5	183.9	183.9
Maximum Flow	gpm	274.2	329.7	389.9	486.6	486.6	486.6	602.3	602.3
<b>Condenser</b>									
Qty of Coils		2	2	2	2	2	2	2	2
Coil Length	ft	108.0	144.0	144.0	144.0	180.0	180.0	216.0	216.0
Coil Height	ft	64.0	64.0	64.0	64.0	64.0	64.0	64.0	64.0
Fin series	fins/ft	192	192	192	192	192	192	192	192
Number of Rows		3/3	2/2	3/3	3/3	3/3	3/3	3/3	3/3
<b>Condenser Fans</b>									
Quantity (1)		3/3	3/3	3/3	3/3	5/4	5/5	6/5	6/6
Diameter	ft	30	30	30	30	30	30	30	30
Total Air Flow	cfm	40725	48967	46425	46467	64160	67974	77848	81556
Nominal RPM		730	730	730	730	730	730	730	730
Tip Speed	ft/s	98	98	98	98	98	98	98	98
Motor kW	kW	1.12	1.12	1.12	1.12	1.12	1.12	1.12	1.12
<b>Min Starting/Oper Ambient(2)</b>									
Standard Unit	°F	32	32	32	32	32	32	32	32
Low Ambient Unit	°F	0	0	0	0	0	0	0	0
<b>General Unit</b>									
Refrigerant		HFC 134a	HFC 134a	HFC 134a	HFC 134a	HFC 134a	HFC 134a	HFC 134a	HFC 134a
No. Of independent Refrigerant Circuits		2	2	2	2	2	2	2	2
% Minimum Load (3)		17	17	17	17	17	17	17	17
Operating Weight (4)	lb	6085	7066	8058	8091	9612	10185	12214	12401
Shipping Weight (4)	lb	5864	6482	7584	7650	9171	9744	11310	11497

**Notes:**

- (1) Data containing information on two circuits shown as follows: ckt1/ckt2
- (2) Minimum start-up/operation ambient based on a 2.22 m/s (5mph) wind across the condenser.
- (3) Percent minimum load is for total machine at 10°C (50°F) ambient and 7°C (44°F) leaving chilled water temperature, not each individual circuit.
- (4) With aluminium fins.
- (5) At Eurovent conditions, 7°C leaving water temperature and 35°C entering condenser air temperature.
- (6) Ratings based on sea level altitude and evaporator fouling factor or 0.017615 m<sup>2</sup>°K/kW
- (7) Unit kW input, including fans



# General Data

**Table G-12 - General Data RTAD High Efficiency Low Noise**

Size		85	100	115	125	145	150
Cooling capacity (5) (6)	tons	82.6	99.9	116.3	136.0	146.3	156.8
Power input (7)	kW	96.1	122.4	146.5	179.1	184.5	203.6
Energy Efficiency Ratio (5) (6) (as Eurovent)	MBH/kW	10.30	9.79	9.52	9.11	9.52	9.25
ESEER (as Eurovent)	MBH/kW	13.68	12.66	12.32	11.84	12.42	11.77
IPLV (According to ARI conditions 44°F leaving water temperature, 95°C entering air temperature)	MBH/kW	15.46	14.36	13.89	13.48	13.89	13.27
<b>Compressor</b>							
Quantity		2	2	2	2	2	2
Nominal Size (1)	tons	40/40	50/50	60/60	70/70	85/70	85/85
<b>Evaporator</b>							
Evpaporator Model		EG140	EG170	EG200	EG200	EG250	EG250
Water Storage	gal.	71.3	58.6	53.9	53.9	109.6	109.6
Minimum Flow	gpm	95.1	115.7	139.5	139.5	183.9	183.9
Maximum Flow	gpm	329.7	389.9	486.6	486.6	602.3	602.3
<b>Condenser</b>							
Qty of Coils		2	2	2	2	2	2
Coil Length	ft	144.0	144.0	180.0	180.0	216.0	216.0
Coil Height	ft	64.0	64.0	64.0	64.0	64.0	64.0
Fin series	fins/ft	192	192	192	192	192	192
Number of Rows		3/3	3/3	3/3	3/3	3/3	3/3
<b>Condenser Fans</b>							
Quantity (1)		3/3	4/4	4/4	5/5	6/5	6/6
Diameter	ft	30	30	30	30	30	30
Total Air Flow	cfm	46361	54286	60282	67910	77763	81471
Nominal RPM		730	730	730	730	730	730
Tip Speed	ft/s	98	98	98	98	98	98
Motor kW	kW	1.12	1.12	1.12	1.12	1.12	1.12
<b>Minimum Starting/Oper Ambient(2)</b>							
Standard Unit	°F	32	32	32	32	32	32
Low Ambient Unit	°F	0	0	0	0	0	0
<b>General Unit</b>							
Refrigerant		HFC 134a	HFC 134a	HFC 134a	HFC 134a	HFC 134a	HFC 134a
No. Of independent Refrigerant Circuits		2	2	2	2	2	2
% Minimum Load (3)		17	17	17	17	17	17
Operating Weight (4)	lb	7363	7871	8830	9039	12103	12225
Shipping Weight (4)	lb	6779	7154	8378	8598	11199	11321

**Notes:**

- (1) Data containing information on two circuits shown as follows: ckt1/ckt2
- (2) Minimum start-up/operation ambient based on a 2.22 m/s (5mph) wind across the condenser.
- (3) Percent minimum load is for total machine at 10°C (50°F) ambient and 7°C (44°F) leaving chilled water temperature, not each individual circuit.
- (4) With aluminium fins.
- (5) At Eurovent conditions, 7°C leaving water temperature and 35°C entering condenser air temperature.
- (6) Ratings based on sea level altitude and evaporator fouling factor of 0.017615 m<sup>2</sup>K/kW
- (7) Unit kW input, including fans

# General Data

**Table G-13 - General Data RTAD Standard Low Noise with Night Noise Set Back**

Size		85	100	115	125	145	150	165	180
Cooling capacity (5) (6)	tons	71.4	90.7	104.2	113.2	137.4	144.6	162.0	172.2
Power input (7)	kW	109.4	133.3	159.4	194.5	207	231.8	238.7	264.3
Energy Efficiency Ratio (5) (6) (as Eurovent)	MBH/kW	7.85	8.15	7.85	6.99	7.98	7.51	8.15	7.81
ESEER (as Eurovent)	MBH/kW	11.19	11.12	10.92	10.00	11.33	10.47	11.12	10.41
IPLV (According to ARI conditions 44°F leaving water temperature, 95°C entering air temperature)	MBH/kW	12.83	12.62	12.59	11.63	12.90	12.01	12.59	11.94
<b>Compressor</b>									
Quantity		2	2	2	2	2	2	2	2
Nominal Size (1)	tons	40/40	50/50	60/60	70/70	85/70	85/85	100/85	100/100
<b>Evaporator</b>									
Evaporator Model		EG120	EG140	EG170	EG200	EG200	EG200	EG250	EG250
Water Storage	gal.	28.0	71.3	58.6	53.9	53.9	53.9	109.6	109.6
Minimum Flow	gpm	65.0	95.1	115.7	139.5	139.5	139.5	183.9	183.9
Maximum Flow	gpm	274.2	329.7	389.9	486.6	486.6	486.6	602.3	602.3
<b>Condenser</b>									
Qty of Coils		2	2	2	2	2	2	2	2
Coil Length	ft	108.0	144.0	144.0	144.0	180.0	180.0	216.0	216.0
Coil Height	ft	64.0	64.0	64.0	64.0	64.0	64.0	64.0	64.0
Fin series	fins/ft	192	192	192	192	192	192	192	192
Number of Rows		37318	37289	37318	37318	37318	37318	37318	37318
<b>Condenser Fans</b>									
Quantity (1)		2/2	3/3	3/3	3/3	4/4	4/4	5/5	5/5
Diameter	ft	30	30	30	30	30	30	30	30
Total Air Flow	cfm	29601	45090	42250	42293	54625	54646	66851	66893
Nominal RPM		690	690	690	690	690	690	690	690
Tip Speed	ft/s	92	92	92	92	92	92	92	92
Motor kW	kW	0.75	0.75	0.75	0.75	0.75	0.75	0.75	0.75
<b>Minimum Starting/Oper Ambient(2)</b>									
Standard Unit	°F	32	32	32	32	32	32	32	32
Low Ambient Unit	°F	0	0	0	0	0	0	0	0
<b>General Unit</b>									
Refrigerant		HFC 134a	HFC 134a	HFC 134a	HFC 134a	HFC 134a	HFC 134a	HFC 134a	HFC 134a
No. Of independent Refrigerant Circuits		2	2	2	2	2	2	2	2
% Minimum Load (3)		17	17	17	17	17	17	17	17
Operating Weight (4)	lb	5886	7066	8058	8091	9612	10185	12214	12401
Shipping Weight (4)	lb	5644	6482	7584	7650	9171	9744	11310	11497

**Notes:**

- (1) Data containing information on two circuits shown as follows: ckt1/ckt2
- (2) Minimum start-up/operation ambient based on a 2.22 m/s (5mph) wind across the condenser.
- (3) Percent minimum load is for total machine at 10°C (50°F) ambient and 7°C (44°F) leaving chilled water temperature, not each individual circuit.
- (4) With aluminium fins.
- (5) At Eurovent conditions, 7°C leaving water temperature and 35°C entering condenser air temperature.
- (6) Ratings based on sea level altitude and evaporator fouling factor or 0.017615 m<sup>2</sup>°K/kW
- (7) Unit kW input, including fans

# General Data

**Table G-14 - General Data RTAD High Efficiency Low Noise with Night Noise Set Back**

Size		85	100	115	125	145	150
Cooling capacity (5) (6)	tons	81.3	95.1	114.6	130.6	143.0	151.9
Power input (7)	kW	97.5	128.6	150	189.6	191	213
Energy Efficiency Ratio (5) (6) (as Eurovent)	MBH/kW	10.00	8.87	9.18	8.26	8.97	8.56
ESEER (as Eurovent)	MBH/kW	13.51	12.08	12.04	11.23	12.11	11.33
IPLV (According to ARI conditions 44°F leaving water temperature, 95°C entering air temperature)	MBH/kW	15.32	13.82	13.65	12.83	13.61	12.86
<b>Compressor</b>							
Quantity		2	2	2	2	2	2
Nominal Size (1)	tons	40/40	50/50	60/60	70/70	85/70	85/85
<b>Evaporator</b>							
Evpaporator Model		EG140	EG170	EG200	EG200	EG250	EG250
Water Storage	gal.	71.3	58.6	53.9	53.9	109.6	109.6
Minimum Flow	gpm	95.1	115.7	139.5	139.5	183.9	183.9
Maximum Flow	gpm	329.7	389.9	486.6	486.6	602.3	602.3
<b>Condenser</b>							
Qty of Coils		2	2	2	2	2	2
Coil Length	ft	144.0	144.0	180.0	180.0	216.0	216.0
Coil Height	ft	64.0	64.0	64.0	64.0	64.0	64.0
Fin series	fins/ft	192	192	192	192	192	192
Number of Rows		37318	37318	37318	37318	37318	37318
<b>Condenser Fans</b>							
Quantity (1)		3/3	3/3	4/4	4/4	5/5	5/5
Diameter	ft	30	30	30	30	30	30
Total Air Flow	cfm	42145	42208	54519	54582	66766	66808
Nominal RPM		690	690	690	690	690	690
Tip Speed	ft/s	92	92	92	92	92	92
Motor kW	kW	0.75	0.75	0.75	0.75	0.75	0.75
<b>Minimum Starting/Oper Ambient(2)</b>							
Standard Unit	°F	32	32	32	32	32	32
Low Ambient Unit	°F	0	0	0	0	0	0
<b>General Unit</b>							
Refrigerant		HFC 134a	HFC 134a	HFC 134a	HFC 134a	HFC 134a	HFC 134a
No. Of independent Refrigerant Circuits		2	2	2	2	2	2
% Minimum Load (3)		17	17	17	17	17	17
Operating Weight (4)	lb	7584	7871	8830	9072	12103	12225
Shipping Weight (4)	lb	7000	7154	8378	8631	11199	11321

**Notes:**

- (1) Data containing information on two circuits shown as follows: ckt1/ckt2
- (2) Minimum start-up/operation ambient based on a 2.22 m/s (5mph) wind across the condenser.
- (3) Percent minimum load is for total machine at 10°C (50°F) ambient and 7°C (44°F) leaving chilled water temperature, not each individual circuit.
- (4) With aluminium fins.
- (5) At Eurovent conditions, 7°C leaving water temperature and 35°C entering condenser air temperature.
- (6) Ratings based on sea level altitude and evaporator fouling factor of 0.017615 m<sup>2</sup>°K/kW
- (7) Unit kW input, including fans

# General Data

**Table G-15 - General Data RTAD Standard High External Static Pressure**

Size		85	100	115	125	145	150	165	180
Cooling capacity (5) (6)	tons	75.2	90.3	104.1	113.1	140.0	149.8	164.3	176.7
Power input (7)	kW	113.3	145.1	170.4	205.4	217.6	238.9	253.2	275.9
Energy Efficiency Ratio (5) (6) (as Eurovent)	MBH/kW	7.95	7.47	7.34	6.62	7.71	7.54	7.78	7.68
ESEER (as Eurovent)	MBH/kW	9.93	9.55	9.66	9.04	10.03	9.55	9.76	9.42
IPLV (According to ARI conditions 44°F leaving water temperature, 95°C entering air temperature)	MBH/kW	11.09	10.82	11.02	10.44	11.29	10.78	10.95	10.61
<b>Compressor</b>									
Quantity		2	2	2	2	2	2	2	2
Nominal Size (1)	Tons	40/40	50/50	60/60	70/70	85/70	85/85	100/85	100/100
<b>Evaporator</b>									
Evaporator Model		EG120	EG140	EG170	EG200	EG200	EG200	EG250	EG250
Water Storage	gal.	28.0	71.3	58.6	53.9	53.9	53.9	109.6	109.6
Minimum Flow	gpm	65.0	95.1	115.7	139.5	139.5	139.5	183.9	183.9
Maximum Flow	gpm	274.2	329.7	389.9	486.6	486.6	486.6	602.3	602.3
<b>Condenser</b>									
Qty of Coils		2	2	2	2	2	2	2	2
Coil Length	ft	108.0	144.0	144.0	144.0	180.0	180.0	216.0	216.0
Coil Height	ft	64.0	64.0	64.0	64.0	64.0	64.0	64.0	64.0
Fin series	fins/ft	192	192	192	192	192	192	192	192
Number of Rows		37683	37654	37683	37683	37683	37683	37683	37683
<b>Condenser Fans</b>									
Quantity (1)		3/3	3/3	3/3	3/3	5/4	5/5	6/5	6/6
Diameter	ft	30	30	30	30	30	30	30	30
Total Air Flow	cfm	39115	45619	43225	43119	60748	65028	73864	78060
Nominal RPM		935	935	935	935	935	935	935	935
Tip Speed	ft/s	122	122	122	122	122	122	122	122
Motor kW	kW	2.23	2.23	2.23	2.23	2.23	2.23	2.23	2.23
<b>Min Starting/Oper Ambient(2)</b>									
Standard Unit	°F	32	32	32	32	32	32	32	32
Low Ambient Unit	°F	0	0	0	0	0	0	0	0
<b>General Unit</b>									
Refrigerant		R134a	R134a	R134a	R134a	R134a	R134a	R134a	R134a
No. Of independent Refrigerant Circuits		2	2	2	2	2	2	2	2
% Min. Load (3)		17	17	17	17	17	17	17	17
Operating Weight (4)	lb	6085	7066	8058	8091	9392	9965	11993	12181
Shipping Weight (4)	lb	5864	6482	7584	7650	8951	9524	11089	11277

**Notes:**

- (1) Data containing information on two circuits shown as follows: ckt1/ckt2
- (2) Minimum start-up/operation ambient based on a 2.22 m/s (5mph) wind across the condenser.
- (3) Percent minimum load is for total machine at 10°C (50°F) ambient and 7°C (44°F) leaving chilled water temperature, not each individual circuit.
- (4) With aluminium fins.
- (5) At Eurovent conditions, 7°C leaving water temperature and 35°C entering condenser air temperature.
- (6) Ratings based on sea level altitude and evaporator fouling factor or 0.017615 m<sup>2</sup>°K/kW
- (7) Unit kW input, including fans

# General Data

**Table G-16 - General Data RTAD High Efficiency High External Static Pressure**

Size		85	100	115	125	145	150
Cooling capacity (5) (6)	tons	81.2	98.5	114.5	134.1	144.4	154.8
Power input (7)	kW	108.8	138.7	164.4	200.4	207.8	228.6
Energy Efficiency Ratio (5) (6) (as Eurovent)	MBH/kW	8.94	8.53	8.36	8.05	8.36	8.12
ESEER (as Eurovent)	MBH/kW	11.09	10.30	10.24	9.86	10.30	9.79
IPLV (According to ARI conditions 44°F leaving water temperature, 95°C entering air temperature)	MBH/kW	12.52	11.67	11.43	11.05	11.46	10.88
<b>Compressor</b>							
Quantity		2	2	2	2	2	2
Nominal Size (1)	tons	40/40	50/50	60/60	70/70	85/70	85/85
<b>Evaporator</b>							
Evpaporator Model		EG140	EG170	EG200	EG200	EG250	EG250
Water Storage	gal.	71.3	58.6	53.9	53.9	109.6	109.6
Minimum Flow	gpm	95.1	115.7	139.5	139.5	183.9	183.9
Maximum Flow	gpm	329.7	389.9	486.6	486.6	602.3	602.3
<b>Condenser</b>							
Qty of Coils		2	2	2	2	2	2
Coil Length	ft	144.0	144.0	180.0	180.0	216.0	216.0
Coil Height	ft	64.0	64.0	64.0	64.0	64.0	64.0
Fin series	fins/ft	192	192	192	192	192	192
Number of Rows		37683	37683	37683	37683	37683	37683
<b>Condenser Fans</b>							
Quantity (1)		3/3	4/4	4/4	5/5	6/5	6/6
Diameter	ft	30	30	30	30	30	30
Total Air Flow	cfm	43437	52167	56595	65134	73991	78208
Nominal RPM		935	935	935	935	935	935
Tip Speed	ft/s	122	122	122	122	122	122
Motor kW	kW	2.23	2.23	2.23	2.23	2.23	2.23
<b>Minimum Starting/Oper Ambient(2)</b>							
Standard Unit	°F	32	32	32	32	32	32
Low Ambient Unit	°F	0	0	0	0	0	0
<b>General Unit</b>							
Refrigerant		R134a	R134a	R134a	R134a	R134a	R134a
No. Of independent Refrigerant Circuits		2	2	2	2	2	2
% Minimum Load (3)		17	17	17	17	17	17
Operating Weight (4)	lb	7363	7650	8830	9039	11883	12004
Shipping Weight (4)	lb	6779	6934	8378	8598	10979	11100

**Notes:**

- (1) Data containing information on two circuits shown as follows: ckt1/ckt2
- (2) Minimum start-up/operation ambient based on a 2.22 m/s (5mph) wind across the condenser.
- (3) Percent minimum load is for total machine at 10°C (50°F) ambient and 7°C (44°F) leaving chilled water temperature, not each individual circuit.
- (4) With aluminium fins.
- (5) At Eurovent conditions, 7°C leaving water temperature and 35°C entering condenser air temperature.
- (6) Ratings based on sea level altitude and evaporator fouling factor or 0.017615 m<sup>2</sup>/K/kW
- (7) Unit kW input, including fans

# Hydraulic Data

**Figure 4 - Evaporator Water Pressure Drops (SI units)**

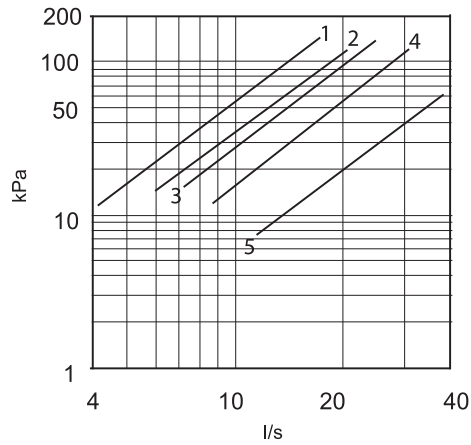

- 1 = 085 STD
- 2 = 115 STD, 100 HE
- 3 = 100 STD, 085 HE
- 4 = 125 STD, 145 STD, 150 STD, 115 HE, 125 HE
- 5 = 165 STD, 180 STD, 145 HE, 150 HE

Note: Valid for standard, Free-cooling and Heat Recovery versions

**Figure 5 - RTAD 115HE - 125HE - 145SE - 150SE Single pump available static pressure**

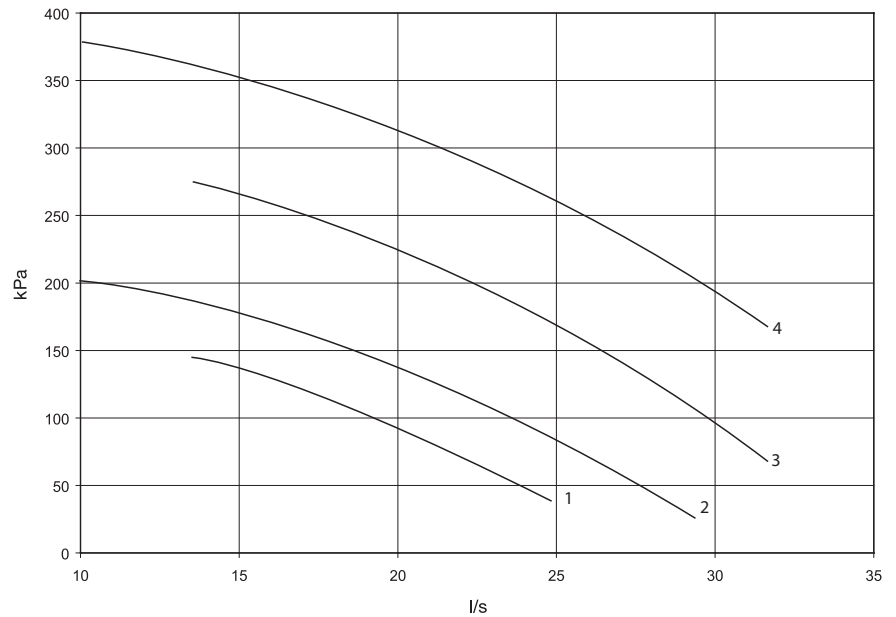

- 1 = LRN 208-13/5.5
- 2 = LRN 208-14/7.5
- 3 = SIL 208-16/11
- 4 = SIL 208-17/15

# Hydraulic Data

**Figure 6 - RTAD 115HE - 125HE - 145SE - 150SE Dual pump available static pressure**

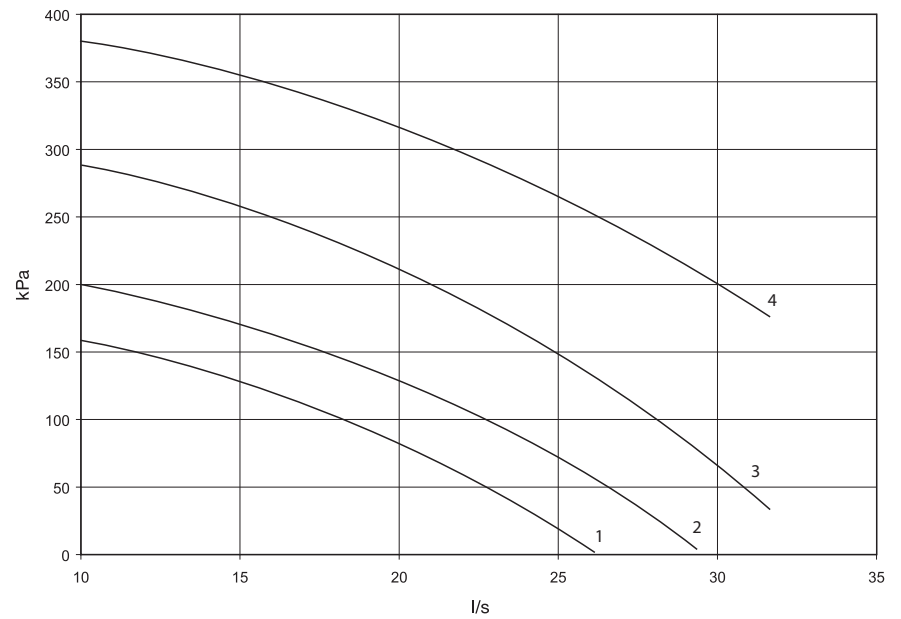

- 1 = JRN 208-13/5.5
- 2 = JRN 208-14/7.5
- 3 = DIL 208-16/11
- 4 = DIL 208-17/15

**Figure 7 - RTAD 145HE - 150HE - 165SE - 180SE Single Pump Available Static Pressure**

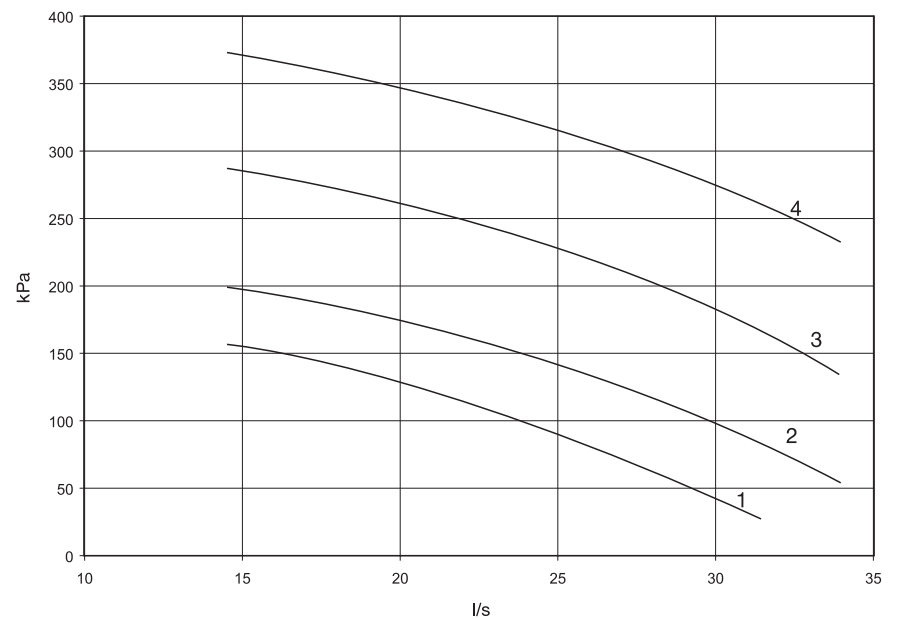

- 1 = LRN 208-13/5.5
- 2 = LRN 208-14/7.5
- 3 = SIL 208-16/11
- 4 = SIL 208-17/15



# Hydraulic Data

**Figure 8 - RTAD 145HE - 150HE - 165SE - 180SE Dual pump Available static pressure**

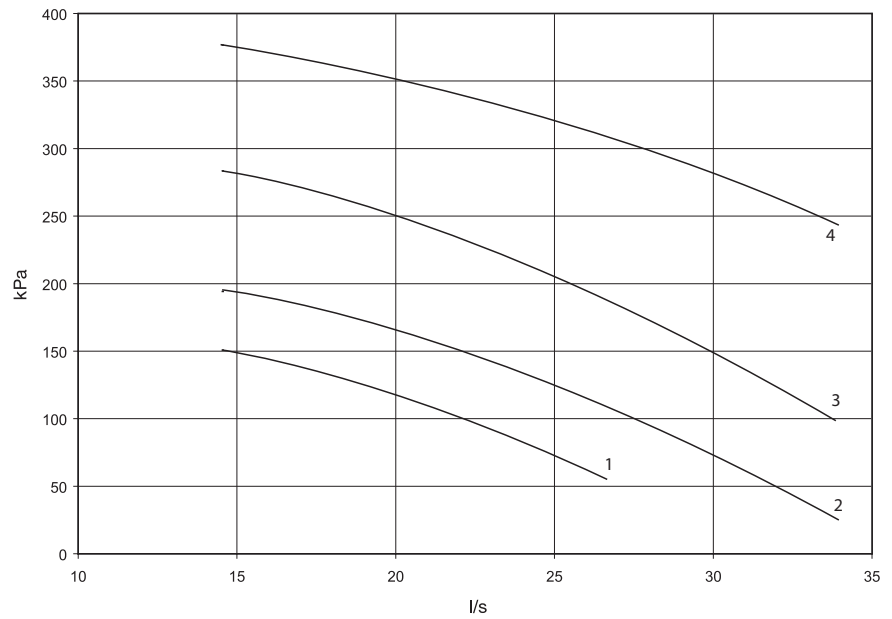

- 1 = JRN 208-13/5.5
- 2 = JRN 208-14/7.5
- 3 = DIL 208-16/11
- 4 = DIL 208-17/15

**Figure 9 - RTAD 115HE - 125HE - 145SE - 150SE Pump Capacity Curve Single Pump**

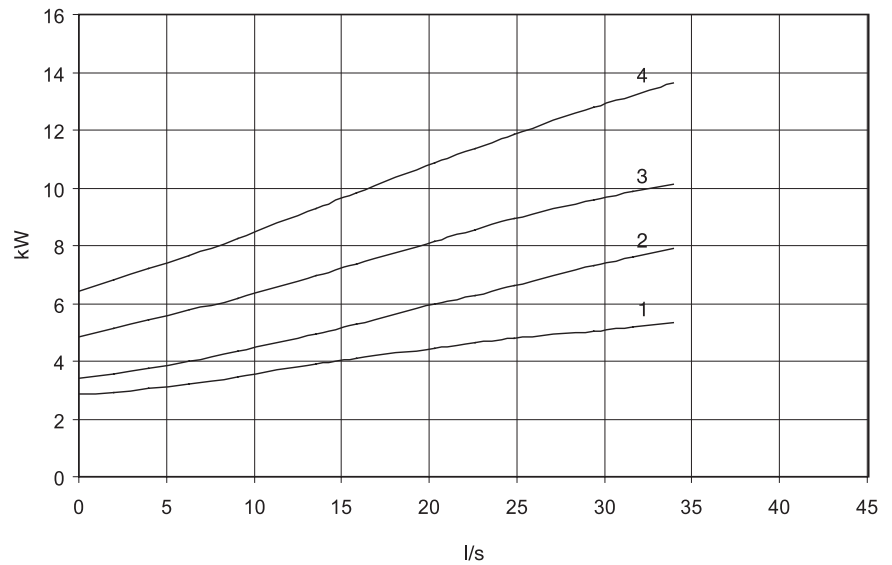

- 1 = LRN 208-13/5.5
- 2 = LRN 208-14/7.5
- 3 = SIL 208-16/11
- 4 = SIL 208-17/15

# Hydraulic Data

**Figure 10 - RTAD 115HE - 125HE - 145SE - 150 SE Pump Capacity Curve Dual Pump**

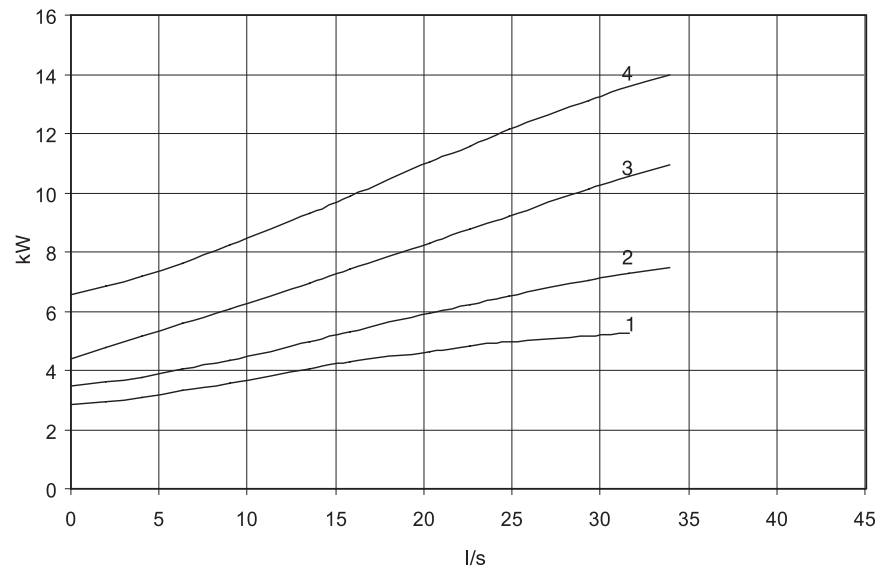

- 1 = LRN 208-13/5.5
- 2 = LRN 208-14/7.5
- 3 = SIL 208-16/11
- 4 = SIL 208-17/15

**Figure 11 - RTAD 145HE - 150HE - 165SE - 180SE Pump Current Curve Single Pump**

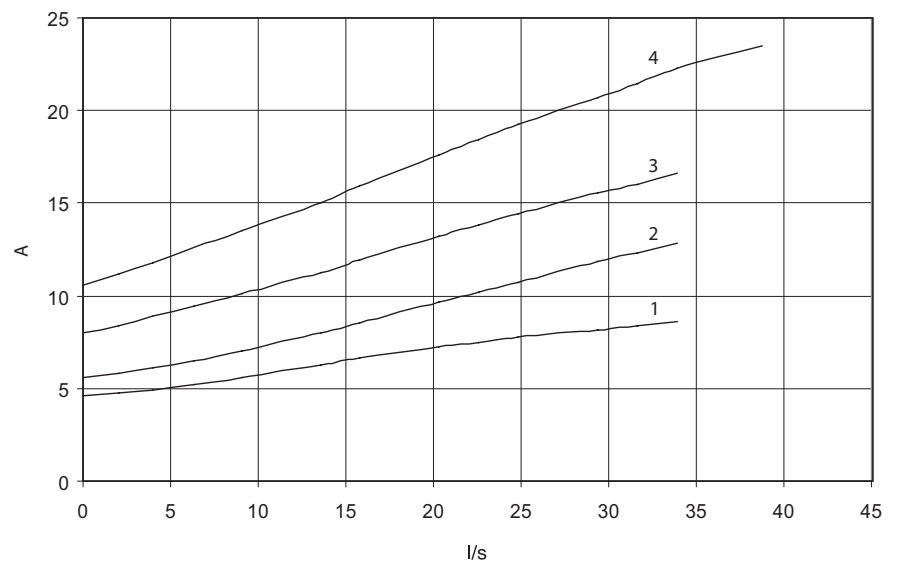

- 1 = JRN 208-13/5.5
- 2 = JRN 208-14/7.5
- 3 = DIL 208-16/11
- 4 = DIL 208-17/15

# Hydraulic Data

Figure 12 - RTAD 145HE - 150HE - 165SE - 180SE Pump Current Curve Dual Pump

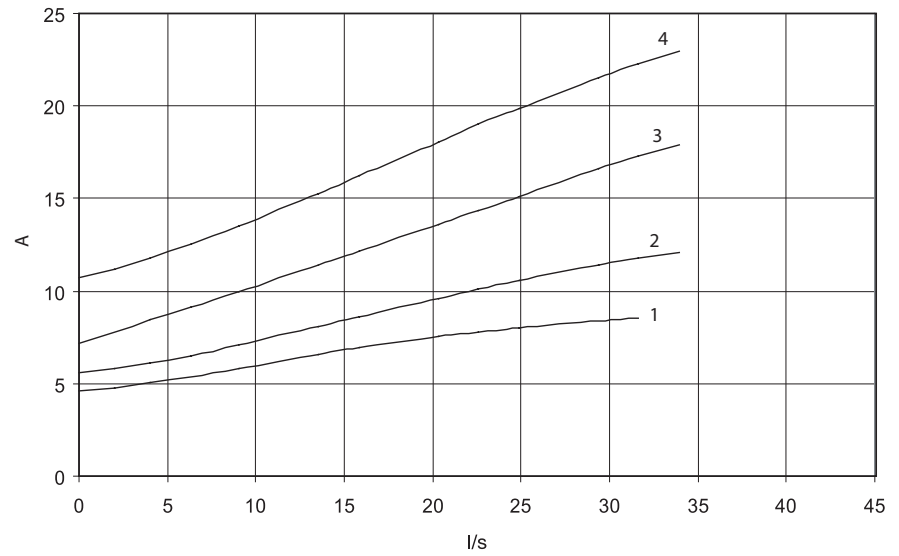

- 1 = JRN 208-13/5.5
- 2 = JRN 208-14/7.5
- 3 = DIL 208-16/11
- 4 = DIL 208-17/15

# Controls

## Chiller Unit Controls

### Trouble-Free Installation, Start-Up and Operation

Adaptive Control means the Unit Control Module (UCM-CLD) directly senses the control variables that govern operation of the chiller: motor current draw, evaporator temperature, condenser temperature, etc. When any of the variables approaches a limit condition where the unit may be damaged or shut down on a safety, the UCM takes corrective action to avoid shutdown and keep the chiller operating. It does this through combined actions of compressor slide valve modulation, electronic expansion valve modulation and fan staging.

Additionally, the UCM optimizes total unit power consumption during normal operating conditions.

No other chiller control system in the marketplace duplicates this performance.

### Safety Controls

A centralized microcomputer offers a higher level of machine protection. Since the safety controls are smarter, they limit compressor operation to avoid compressor or evaporator failures, thereby minimizing nuisance shutdown. During abnormal operating conditions, the UCM will continue to optimize chiller performance by taking the corrective action necessary to avoid shutdown.

This keeps cooling capacity available until the problem can be solved. Whenever possible, the chiller is allowed to perform its function; make chilled water. In

addition, microcomputer controls allow for more types of protection such as over and under voltage! Overall, the safety controls help keep the building running and out of trouble.

### The End Of Nuisance Trip-Outs And Unnecessary Service Calls

Unnecessary service calls and unhappy tenants are avoided. The unit does not nuisance trip or unnecessarily shut down. Only when the UCM has exhausted the corrective actions it can take and the unit is still violating an operating limit will the unit shut down. CONTROLS ON OTHER CHILLERS TYPICALLY SHUT DOWN THE CHILLER, QUITE PROBABLY JUST WHEN IT IS NEEDED THE MOST.

#### For example:

A typical five-year-old chiller with dirty coils might trip-out on high pressure cutout on a 38°C day in August. A hot day is just when comfort cooling is needed the most. In contrast, the air-cooled Series R chiller with an Adaptive Control microprocessor will stage fans on, modulate electronic expansion valve, and modulate slide valve as it approaches a high pressure cutout. Thereby KEEPING THE CHILLER ON-LINE JUST WHEN YOU NEED IT THE MOST.

Figure 13 - Unit control module with Clear Language Display Keypad (UCM-CLD)



## Generic Building Automation System Controls

### Simple Interface With Other Control Systems

Microcomputer controls afford simple interface with other control systems, such as time clocks, building automation systems and ice storage systems. Wiring to the unit can be as simple as two wires! This means you can have the flexibility to meet job requirements while not having to learn a complicated control system.

# Controls

## Monitoring And Diagnostics

Since the microcomputer provides all control functions, it can easily indicate such parameters as leaving chilled water temperature and capacity stage. If a failure does occur, one of over 90 individual diagnostic and operating codes will be used to indicate the problem, giving more specific information about the failure. All of the monitoring and diagnostic information is displayed directly on a microcomputer display.

## Interface With The Trane Integrated Comfort™ System (ICS)

When the air-cooled Series R® chiller is used in conjunction with a Trane Tracer® system, the unit can be monitored and controlled from a remote location. The air-cooled Series R chiller can be controlled to fit into the overall building automation strategy by using time of day scheduling, timed override, duty cycling, demand limiting, and chiller sequencing. A building owner can completely monitor the air-cooled Series R chiller from the Tracer system, as all of the monitoring information indicated on the microcomputer can be read off the Tracer system display. In addition, all the powerful diagnostic information can be read back at the Tracer system. Best of all, this powerful capability comes over a single twisted pair of wires! Air-cooled Series R chillers can interface with many different external control systems, from simple stand-alone units to ice making systems. Each unit requires a single-source, three-phase power supply, a 115-volt control power transformer handles both the evaporator heat tape and the unit controls. The control transformer is directly fed from the 400/3/50 supply in the control panel. For basic stand-alone applications, the interface with outside control is no different than for other Trane chillers. However, the RTAD units have many

features that can be used to interface with building control systems.

## Standard Features:

### External Auto/Stop

A job site provided contact closure will turn the unit on and off.

Note: Do not use the chilled water pump to stop the chiller.

### Chilled Water flow Interlock

A job site provided contact closure from a chilled water pump contactor or a flow switch is required and will allow unit operation if a load exists. This feature will allow the unit to run in conjunction with the pump system.

### External Interlock

A job site supplied contact opening wired to this input will turn the unit off and require a manual reset of the unit microcomputer. This closure is typically triggered by a job site supplied system such as a fire alarm.

### Chilled Water Pump Control

Unit controls provide an output to control chilled water pump(s). One contact closure to the chiller is all that is required to initiate the chilled water system.

### Remote Running and Alarm Indication Contacts

The unit provides three single-pole/double-throw contact closures to indicate that a failure has occurred, if any compressors are running, or if the compressors are running at maximum capacity. These contact closures may be used to trigger job site supplied alarm lights or alarm bells.

## Optional Features:

### Communication Interface (CSR Communication Interface Option)

Capability for communication with Trane Tracer® Building

Automation Systems or Remote Display

### External Chilled Water Set point

Allows the external setting independent of the front panel setpoint by a 2-10 VDC input, or a 4-20 mA input.

### External Current Limit Set point

Allows the external setting independent of the front panel setpoint by a 2-10 VDC input, or a 4-20 mA input.

### Ice Making Control

Provides interface with ice making control systems.

### Chilled Water Temperature Reset

Reset can be based on return water temperature or outdoor air temperature.

## Interface with other control systems

### Stand-Alone Unit

Interface to stand-alone units is very simple; only a remote auto/stop for scheduling is required for unit operation. Signals from the chilled water pump contactor auxiliary or a flow switch are wired to the chilled water flow interlock. Signals from a time clock or some other remote device are wired to the external auto/stop input.

**Note: Do not use the chilled water pump to stop the chiller.**

### Required Features

External Auto/Stop (Standard)  
Chilled Water flow Interlock (Standard)

### Additional Features That May Be Used

Remote Running and Alarm Indication Contacts (provided on the UCM-CLD main module)  
External Interlock (Standard)  
Chilled Water Temperature Reset

# Controls

**External Trane Devices Required -**  
None

**Note:** All wiring outside the unit is supplied at the job site.

## TRANE Integrated Comfort™ System Interface

A single twisted pair of wires tied directly between the air-cooled Series R® chiller and a Tracer® system provides control, monitoring and diagnostic capabilities. Control functions include auto/stop, adjustment of leaving water temperature set point, compressor operation lockout for kW demand limiting and control of ice making mode. The Tracer system reads monitoring information such as entering and leaving evaporator water temperatures and outdoor air temperature. Over 60 individual diagnostic codes can be read by the Tracer system. In addition, the Tracer system can provide sequencing control for two to six units on the same chilled water loop. Pump sequencing control can be provided from the Tracer system. Tracer ICS is not available in conjunction with the remote display or the external set point capability.

**Required Features**  
Communications Interface (Requires CSR Communications Interface, option)

**Additional Features That May Be Used**  
Chilled Water Temperature Reset  
Ice Making Control

**External Trane Devices Required**  
Tracer Summit® or Tracer Chiller Plant Control

## Interface With Other Building Automation Systems

The air-cooled Series R chillers can interface with non-Trane building automation systems via hard wire connections. Several capabilities may be utilized:

**Required Features**  
External Auto/Stop (Standard)

**Additional Features That May Be Used**  
External Interlock (Standard)  
External Demand Limit (Set point) (Requires CSR Communications Interface, option)  
Remote Running and Alarm Indication Contacts (Standard)  
External Chilled Water Set point (Requires CSR Communications Interface, option)  
Chilled Water flow Interlock (Standard)

**External Trane Devices Required -**  
None

## Ice Making Systems

An ice making option may be ordered with the air-cooled Series R® chiller. The unit will have two operating modes, ice making and normal daytime cooling. In the ice making mode, the air-cooled Series R chiller will operate at full compressor capacity until the return chilled fluid temperature entering the evaporator meets the ice making set point. This ice making set point is manually adjusted on the unit's microcomputer. Two input signals are required to the air-cooled Series R chiller for the ice making option. The first is an auto/stop signal for scheduling and the second is required to switch the unit in between the ice making mode and normal daytime operation. The signals are provided by a remote job site building automation device such as a time clock or a manual switch.

In addition, the signals may be provided over the twisted wire pair from a Tracer® system.

**Required Features**  
External Auto/Stop (Standard)  
Ice Making Control (Requires CSR Communications Interface, option)

**Additional Features That May Be Used**  
Remote Running and Failure Indication Contacts  
Communications Interface (For Tracer Systems)  
Chilled Water Temperature Reset (Indoor zone reset not available with ice making option).

**External Trane Devices Required -**  
None

# Controls

## Remote Display

The remote display allows the operator to monitor chiller operation from a location within the building. Over 60 essential chiller operating parameters can be transmitted between the unit control module on the chiller and the remote display via a bi-directional communications link. Only one twisted wire pair is required between the chiller and the remote display. In addition to monitoring chiller operation, alarms and unit diagnostics can be read from the remote display. Furthermore, the chilled water temperature set point can be adjusted and the chiller can be turned on or off from the remote display.

### Required Features

Communications Interface

### Additional Features That May Be Used

External Interlock (Standard)  
Chilled Water Temperature Reset  
Chilled Water flow Interlock (Standard)  
Remote Running and Failure Indication Contacts

### External Trane Devices Required

Remote Display Panel

Figure 14 - Remote display panel





# Job Site Data

**Table J-1 - Customer Wire Selection 400/3/50**

Unit Size	Unit without Disconnect Switch		Unit with Disconnect Switch	
	Wire Selection Size to Main Terminal Block		Wire Selection Size to Disconnect Switch	
	Maximum cable size (mm <sup>2</sup> )	Disconnect Switch Size (A)	Disconnect Switch Size (A)	Maximum cable size (mm <sup>2</sup> )
<b>Standard</b>				
085	2x300	250	250	150
100	2x300	400	400	240
115	2x300	400	400	240
125	2x300	500	500	240
145	2x300	500	500	240
150	2x300	630	630	2 x 300
165	2x300	630	630	2 x 300
180	2x300	630	630	2 x 300
<b>High Efficiency</b>				
085	2x300	250	250	150
100	2x300	400	400	240
115	2x300	400	400	240
125	2x300	500	500	240
145	2x300	500	500	240
150	2x300	630	630	2 x 300
<b>High Ambient</b>				
085	2x300	400	400	240
100	2x300	400	400	240
115	2x300	400	400	240
125	2x300	500	500	240
145	2x300	630	630	2 x 300
150	2x300	630	630	2 x 300
165	2x300	630	630	2 x 300
180	2x300	800	800	2 x 300
<b>Standard Low Noise</b>				
085	2x300	250	250	150
100	2x300	400	400	240
115	2x300	400	400	240
125	2x300	500	500	240
145	2x300	500	500	240
150	2x300	630	630	2 x 300
165	2x300	630	630	2 x 300
180	2x300	630	630	2 x 300
<b>High Efficiency Low Noise</b>				
085	2x300	250	250	150
100	2x300	400	400	240
115	2x300	400	400	240
125	2x300	500	500	240
145	2x300	500	500	240
150	2x300	630	630	2 x 300

Unit Size	Unit without Disconnect Switch		Unit with Disconnect Switch	
	Wire Selection Size to Main Terminal Block		Wire Selection Size to Disconnect Switch	
	Maximum cable size (mm <sup>2</sup> )	Disconnect Switch Size (A)	Disconnect Switch Size (A)	Maximum cable size (mm <sup>2</sup> )
<b>Standard Low Noise with Night Noise Set Back</b>				
085	2x300	250	250	150
100	2x300	400	400	240
115	2x300	400	400	240
125	2x300	500	500	240
145	2x300	500	500	240
150	2x300	630	630	2 x 300
165	2x300	630	630	2 x 300
180	2x300	630	630	2 x 300
<b>High Efficiency Low Noise with Night Noise Set Back</b>				
085	2x300	250	250	150
100	2x300	400	400	240
115	2x300	400	400	240
125	2x300	500	500	240
145	2x300	500	500	240
150	2x300	630	630	2 x 300
<b>Standard with High External Static Pressure</b>				
085	2x300	250	250	150
100	2x300	400	400	240
115	2x300	400	400	240
125	2x300	500	500	240
145	2x300	500	500	240
150	2x300	630	630	2 x 300
165	2x300	630	630	2 x 300
180	2x300	630	630	2 x 300
<b>High Efficiency with High External Static Pressure</b>				
085	2x300	250	250	150
100	2x300	400	400	240
115	2x300	400	400	240
125	2x300	500	500	240
145	2x300	500	500	240
150	2x300	630	630	2 x 300

# Electrical Data

**Table E-1 - Unit Wiring 400/3/50**

Unit size	Nbr of Power Connections	Maximum Amps (1)	Unit Wiring		Power Factor (5)	Compressor Fuse Size (A)	Evaporator heater (kW)
			Starting Amps (2)				
<b>Standard</b>							
085	1	242	255		0.90	6 x 125	0.217
100	1	282	306		0.88	6 x 160	0.217
115	1	323	359		0.89	6 x 200	0.217
125	1	387	425		0.90	6 x 250	0.217
145	1	437	471		0.90	6 x 250	0.217
150	1	477	502		0.89	6 x 250	0.217
165	1	527	570		0.89	315 + 250	0.217
180	1	576	608		0.89	6 x 315	0.217
<b>High Efficiency</b>							
85	1	242	255		0.90	6 x 125	0.217
100	1	291	315		0.88	6 x 160	0.217
115	1	332	368		0.89	6 x 200	0.217
125	1	405	443		0.90	6 x 250	0.217
145	1	446	480		0.90	6 x 250	0.217
150	1	486	511		0.89	6 x 250	0.217
<b>High Ambient</b>							
85	1	242	255		0.90	6 x 160	0.217
100	1	291	315		0.88	6 x 200	0.217
115	1	332	368		0.89	6 x 250	0.217
125	1	405	443		0.90	6 x 250	0.217
145	1	446	480		0.90	6 x 250	0.217
150	1	486	511		0.89	6 x 315	0.217
165	1	527	570		0.89	400 + 315	0.217
180	1	576	608		0.89	6 x 400	0.217
<b>Standard Low Noise</b>							
085	1	230	243		0.90	6 x 125	0.217
100	1	270	294		0.88	6 x 160	0.217
115	1	311	347		0.89	6 x 200	0.217
125	1	375	413		0.90	6 x 250	0.217
145	1	419	453		0.90	6 x 250	0.217
150	1	457	482		0.89	6 x 250	0.217
165	1	505	548		0.89	315 + 250	0.217
180	1	552	584		0.89	6 x 315	0.217
<b>High Efficiency Low Noise</b>							
085	1	230	243		0.90	6 x 125	0.217
100	1	275	299		0.88	6 x 160	0.217
115	1	316	352		0.89	6 x 200	0.217
125	1	385	423		0.90	6 x 250	0.217
145	1	424	458		0.90	6 x 250	0.217
150	1	462	487		0.89	6 x 250	0.217
<b>Standard Low Noise with Night Noise Set Back</b>							
085	1	226	238		0.90	6 x 125	0.217
100	1	270	295		0.88	6 x 160	0.217
115	1	312	348		0.89	6 x 200	0.217
125	1	376	414		0.90	6 x 250	0.217
145	1	417	451		0.90	6 x 250	0.217
150	1	453	478		0.89	6 x 250	0.217
165	1	503	546		0.89	315 + 250	0.217
180	1	548	580		0.89	6 x 315	0.217

# Electrical Data

**Table E-1 - Table E-1 - Unit Wiring 400/3/50 Cont**

Unit size	Nbr of Power Connections	Maximum Amps (1)	Unit Wiring		Power Factor (5)	Compressor Fuse Size (A)	Evaporator heater (kW)
			Starting Amps (2)				
<b>High Efficiency Low Noise with Night Noise Set Back</b>							
085	1	231	244		0.90	6 x 125	0.217
100	1	270	295		0.88	6 x 160	0.217
115	1	317	353		0.89	6 x 200	0.217
125	1	381	419		0.90	6 x 250	0.217
145	1	381	456		0.90	6 x 250	0.217
150	1	381	483		0.89	6 x 250	0.217
<b>Standard with High External Static Pressure</b>							
085	1	231	244		0.90	6 x 125	0.217
100	1	278	302		0.88	6 x 160	0.217
115	1	319	355		0.89	6 x 200	0.217
125	1	383	421		0.90	6 x 250	0.217
145	1	427	461		0.90	6 x 250	0.217
150	1	463	488		0.89	6 x 250	0.217
165	1	516	559		0.89	315 + 250	0.217
180	1	561	593		0.89	6 x 315	0.217
<b>High Efficiency with High External Static Pressure</b>							
085	1	239	251		0.90	6 x 125	0.217
100	1	278	302		0.88	6 x 160	0.217
115	1	327	363		0.89	6 x 200	0.217
125	1	391	429		0.90	6 x 250	0.217
145	1	435	469		0.90	6 x 250	0.217
150	1	471	496		0.89	6 x 250	0.217

**Table E-2 Motor Data 400/3/50**

Unit Size	Qty	Compressor (Each)						Fans (Each)				Control	
		RLA Amps		Max Amps		Starting Amps		Qty	kW	FLA	Fans fuse size (A)	VA	(400V) A
		Ckt 1	Ckt 2	Ckt 1	Ckt 2	Ckt 1	Ckt 2						
<b>Standard</b>													
85	2	80	80	106	106	144	144	6	1.72	3.26	3 x 50	1600	4
100	2	95	95	125	125	180	180	6	1.72	3.26	3 x 50	1600	4
115	2	111	111	146	146	217	217	6	1.72	3.26	3 x 50	1600	4
125	2	135	135	178	178	259	259	6	1.72	3.26	3 x 50	1600	4
145	2	162	135	214	178	291	259	9	1.72	3.26	3 x 63	1600	4
150	2	162	162	214	214	291	291	10	1.72	3.26	3 x 63	1600	4
165	2	196	162	259	214	354	291	11	1.72	3.26	3 x 63	1600	4
180	2	196	196	259	259	354	354	12	1.72	3.26	3 x 63	1600	4
<b>High Efficiency</b>													
85	2	80	80	106	106	144	144	6	1.72	3.26	3 x 50	1600	4
100	2	95	95	125	125	180	180	8	1.72	3.26	3 x 50	1600	4
115	2	111	111	146	146	217	217	8	1.72	3.26	3 x 50	1600	4
125	2	135	135	178	178	259	259	10	1.72	3.26	3 x 50	1600	4
145	2	162	135	214	178	291	259	11	1.72	3.26	3 x 63	1600	4
150	2	162	162	214	214	291	291	12	1.72	3.26	3 x 63	1600	4
<b>Standard Low Noise</b>													
85	2	80	80	106	106	144	144	6	1.72	3.26	3 x 50	1600	4
100	2	95	95	125	125	180	180	6	1.72	3.26	3 x 50	1600	4
115	2	111	111	146	146	217	217	6	1.72	3.26	3 x 50	1600	4
125	2	135	135	178	178	259	259	6	1.72	3.26	3 x 50	1600	4
145	2	162	135	214	178	291	259	9	1.72	3.26	3 x 63	1600	4
150	2	162	162	214	214	291	291	10	1.72	3.26	3 x 63	1600	4
165	2	196	162	259	214	354	291	11	1.72	3.26	3 x 63	1600	4
180	2	196	196	259	259	354	354	12	1.72	3.26	3 x 63	1600	4
<b>High Efficiency Low Noise</b>													
85	2	80	80	106	106	144	144	6	1.72	3.26	3 x 50	1600	4
100	2	95	95	125	125	180	180	8	1.72	3.26	3 x 50	1600	4
115	2	111	111	146	146	217	217	8	1.72	3.26	3 x 50	1600	4
125	2	135	135	178	178	259	259	10	1.72	3.26	3 x 50	1600	4
145	2	162	135	214	178	291	259	11	1.72	3.26	3 x 63	1600	4
150	2	162	162	214	214	291	291	12	1.72	3.26	3 x 63	1600	4



# Electrical Data

**Table E-2 Motor Data 400/3/50 cont**

Unit Size	Compressor (Each)							Fans (Each)				Control	
	Qty	RLA Amps		Max Amps		Starting Amps		Qty	kW	FLA	Fans fuse size (A)	VA	(400V) A
		Ckt 1	Ckt 2	Ckt 1	Ckt 2	Ckt 1	Ckt 2						
<b>Standard</b>													
85	2	80	80	106	106	144	144	6	1.72	3.5	3 x 50	1648	4
100	2	95	95	125	125	180	180	6	1.72	3.5	3 x 50	1648	4
115	2	111	111	146	146	217	217	6	1.72	3.5	3 x 50	1648	4
125	2	135	135	178	178	259	259	6	1.72	3.5	3 x 50	1648	4
145	2	162	135	214	178	291	259	9	1.72	3.5	3 x 63	1648	4
150	2	162	162	214	214	291	291	10	1.72	3.5	3 x 63	1648	4
165	2	196	162	259	214	354	291	11	1.72	3.5	3 x 63	1648	4
180	2	196	196	259	259	354	354	12	1.72	3.5	3 x 63	1648	4
<b>High Efficiency</b>													
85	2	80	80	106	106	144	144	6	1.72	3.5	3 x 50	1648	4
100	2	95	95	125	125	180	180	8	1.72	3.5	3 x 50	1648	4
115	2	111	111	146	146	217	217	8	1.72	3.5	3 x 50	1648	4
125	2	135	135	178	178	259	259	10	1.72	3.5	3 x 50	1648	4
145	2	162	135	214	178	291	259	11	1.72	3.5	3 x 63	1648	4
150	2	162	162	214	214	291	291	12	1.72	3.5	3 x 63	1648	4
<b>Standard Low Noise</b>													
85	2	80	80	106	106	144	144	6	1.72	3.5	3 x 50	1648	4
100	2	95	95	125	125	180	180	6	1.72	3.5	3 x 50	1648	4
115	2	111	111	146	146	217	217	6	1.72	3.5	3 x 50	1648	4
125	2	135	135	178	178	259	259	6	1.72	3.5	3 x 50	1648	4
145	2	162	135	214	178	291	259	9	1.72	3.5	3 x 63	1648	4
150	2	162	162	214	214	291	291	10	1.72	3.5	3 x 63	1648	4
165	2	196	162	259	214	354	291	11	1.72	3.5	3 x 63	1648	4
180	2	196	196	259	259	354	354	12	1.72	3.5	3 x 63	1648	4
<b>High Efficiency Low Noise</b>													
85	2	80	80	106	106	144	144	6	1.72	3.5	3 x 50	1648	4
100	2	95	95	125	125	180	180	8	1.72	3.5	3 x 50	1648	4
115	2	111	111	146	146	217	217	8	1.72	3.5	3 x 50	1648	4
125	2	135	135	178	178	259	259	10	1.72	3.5	3 x 50	1648	4
145	2	162	135	214	178	291	259	11	1.72	3.5	3 x 63	1648	4
150	2	162	162	214	214	291	291	12	1.72	3.5	3 x 63	1648	4

# Electrical Data

**Table E-2 Motor Data 400/3/50 cont**

Unit Size	Qty	Compressor (Each)						Fans (Each)			Control		
		RLA Amps		Max Amps		Starting Amps		Qty	kW	FLA	Fans fuse size (A)	VA	(400V) A
		Ckt 1	Ckt 2	Ckt 1	Ckt 2	Ckt 1	Ckt 2						
<b>Standard Low Noise with Night Noise Set Back</b>													
85	2	80	80	106	106	144	144	4	0.85	2	3 x 50	1648	4
100	2	95	95	125	125	180	180	6	0.85	2	3 x 50	1648	4
115	2	111	111	146	146	217	217	6	0.85	2	3 x 50	1648	4
125	2	135	135	178	178	259	259	6	0.85	2	3 x 50	1648	4
145	2	162	135	214	178	291	259	8	0.85	2	3 x 63	1648	4
150	2	162	162	214	214	291	291	8	0.85	2	3 x 63	1648	4
165	2	196	162	259	214	354	291	10	0.85	2	3 x 63	1648	4
180	2	196	196	259	259	354	354	10	0.85	2	3 x 63	1648	4
<b>High Efficiency Low Noise night Noise Set Back</b>													
85	2	80	80	106	106	144	144	6	0.85	2	3 x 50	1648	4
100	2	95	95	125	125	180	180	6	0.85	2	3 x 50	1648	4
115	2	111	111	146	146	217	217	8	0.85	2	3 x 50	1648	4
125	2	135	135	178	178	259	259	8	0.85	2	3 x 50	1648	4
145	2	162	135	214	178	291	259	10	0.85	2	3 x 63	1648	4
150	2	162	162	214	214	291	291	10	0.85	2	3 x 63	1648	4
<b>Standard with High External Static Pressure</b>													
85	2	80	80	106	106	144	144	4	2.6	5.5	3 x 50	1648	4
100	2	95	95	125	125	180	180	6	2.6	5.5	3 x 50	1648	4
115	2	111	111	146	146	217	217	6	2.6	5.5	3 x 50	1648	4
125	2	135	135	178	178	259	259	6	2.6	5.5	3 x 50	1648	4
145	2	162	135	214	178	291	259	8	2.6	5.5	3 x 63	1648	4
150	2	162	162	214	214	291	291	8	2.6	5.5	3 x 63	1648	4
165	2	196	162	259	214	354	291	10	2.6	5.5	3 x 63	1648	4
180	2	196	196	259	259	354	354	10	2.6	5.5	3 x 63	1648	4
<b>High Efficiency with High External Static Pressure</b>													
85	2	80	80	106	106	144	144	6	2.6	5.5	3 x 50	1648	4
100	2	95	95	125	125	180	180	6	2.6	5.5	3 x 50	1648	4
115	2	111	111	146	146	217	217	8	2.6	5.5	3 x 50	1648	4
125	2	135	135	178	178	259	259	8	2.6	5.5	3 x 50	1648	4
145	2	162	135	214	178	291	259	10	2.6	5.5	3 x 63	1648	4
150	2	162	162	214	214	291	291	10	2.6	5.5	3 x 63	1648	4

## Dimensional Data

RTAD	unit type		12	Copper fins	Coil protection guards	1 + 2
85	STD	X - P - Q	2660	+ 280	+ 86	ø5" 1/2 DN 125 PN
		L	2760			
	HE	X - P	3240			
100	STD	L - Q	3340	+ 250	+ 97	
		X - P	3105			
	HE	L - Q	3205			
115	STD	X - P - Q	3370	+ 340		
		L	3470			
	HE	X - P	3555			
125	STD	L - Q	3655	+ 430	+ 113	
		X - P	3905			
	HE	L - Q	4005			
145	STD	X - P	3570	+ 340	+ 97	ø6" DN 150 - PN 16
		L - Q	3670			
	HE	X - P - Q	4000			
150	STD	L	4100	+ 430	+ 113	
		X - P	4260			
	HE	L	4360			
165	STD	Q	4310	+ 510	+ 137	
		X - P	5390			
	HE	L	5490			
180	STD	Q	5440	+ 430	+ 113	
		X - P - Q	4520			
	HE	L	4620			
180	STD	X - P - Q	5445	+ 510	+ 137	
		L	5545			
	HE	X - P	5440			
180	STD	L	5540	+ 510	+ 137	
		Q	5490			
	HE	X - P - Q	5525			
180	STD	L	5625			

12 = operating weight with aluminum fins + power disconnect switch + isolators + pressure gauges

1 = Evaporator water inlet connection

2 = Evaporator water outlet connection

STD = standard unit

HE = high efficiency unit

X = standard fans

L = Low noise fans

Q = low noise Night Noise Set back fans

P = high external static pressure fans (100Pa)

# Dimensional Data

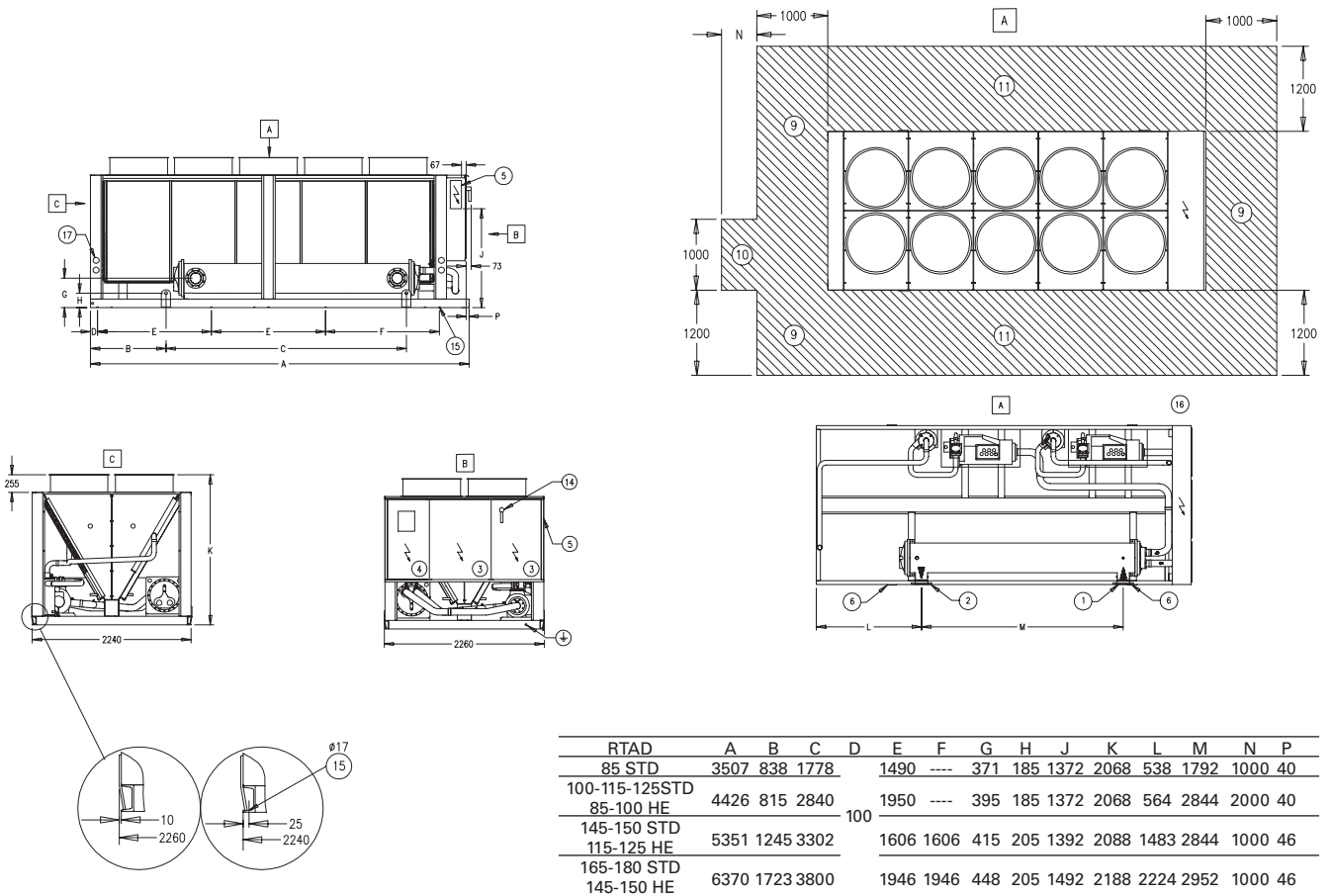

Note: for High Efficiency Low noise and High ambient units, use dimensions of the High efficiency units.

## Dimensional Data

**Table - Hydraulic module additional operating weight**

		Expansion vessel					
		Without (kg)	Without (lbs)	50 litres (kg)	50 litres (lbs)	80 litres (kg)	80 litres (lbs)
<b>RTAD 115 HE - RTAD 125 HE - RTAD 145 SE - RTAD 150 SE</b>		Pump model					
Single pump	LRN 208-13/5.5 - LRN 208-14/7.5	400	882	460	1014	500	1102
	SIL 208-16/11 - SIL 208-17/15	455	1003	515	1135	555	1224
Dual pump	JRN 208-13/5.5 - JRN 208-14/7.5	490	1080	550	1213	590	1301
	SIL 208-16/11 - SIL 208-17/15	600	1323	660	1455	700	1543
<b>RTAD 145 HE - RTAD 150 HE - RTAD 165 SE - RTAD 180 SE</b>		Pump model					
Single pump	LRN 208-13/5.5 - LRN 208-14/7.5	510	1124	570	1257	610	1345
	SIL 208-16/11 - SIL 208-17/15	565	625	625	1378	665	1466
Dual pump	JRN 208-13/5.5 - JRN 208-14/7.5	600	1323	660	1455	700	1543
	SIL 208-16/11 - SIL 208-17/15	710	1565	770	1698	810	1786



# Mechanical Specifications

## General

Units are leak and pressure tested at 35 bar high side, 19 bar low side, then evacuated and charged.

Packaged units ship with a full operating charge of oil and refrigerant.

Unit panels, structural elements and control boxes are constructed of galvanized steel and mounted on a welded structural steel base. Unit panels and control boxes are finished with an air-dry paint RAL 1019.

## Evaporator

The evaporator is a tube-in-shell heat exchanger design with internally finned copper tubes roller expanded into the tube sheet. The evaporator is designed, tested and stamped in accordance with the appropriate pressure vessel code approval for a refrigerant side working pressure of 32 bar. The evaporator is designed for a water side working pressure of 14 bar. Water connections are flanged. The evaporator has one water pass with a series of internal baffles. Each shell includes a vent, a drain and fittings for temperature control sensors and is insulated with 3/4 - inch Armaflex II or equal insulation (K=0.26). Heat tape is provided to protect the evaporator from freezing at ambient temperatures down to -18°C.

## Condenser and Fans

Air-cooled condenser coils have aluminum fins mechanically bonded to internally finned seamless copper tubing. The condenser coil has an integral subcooling circuit.

Condensers are factory proof and leak tested at 35 bar. Direct-drive vertical discharge air foil ZephyrWing condenser fans are dynamically balanced. Three-phase condenser fans motors with permanently lubricated ball bearing are provided. Standard units will

start and operate between of 4°C (39 F) to the maximum possible ambient of the selected unit.

## Compressor and Lube Oil System

The rotary screw compressor is semi-hermetic, direct drive, 3000 rpm, with capacity control slide valve, a load/unload valve, rolling element bearings, differential refrigerant pressure oil pump, oil filter and oil heater. The motor is a suction gas cooled, hermetically sealed, two-pole squirrel cage induction motor. Oil separator devices are provided separate from the compressor. Check valves in the compressor discharge and lube oil system are provided.

## Refrigeration Circuits

Each unit has two refrigerant circuits, with one rotary screw compressor per circuit. Each refrigerant circuit includes a liquid line shutoff valve, removable core filter drier, charging port and an electronic expansion valve. Fully modulating compressors and electronic expansion valves provide variable capacity modulation over the entire operating range.

## Unit Controls

All unit controls are housed in a weather-tight enclosure with hinged doors to allow for customer connection of power wiring and remote interlocks.

All controls, including sensors, are factory mounted and tested prior to shipment. All cataloged units comply to EN 60204 and are EMC compatible.

Microcomputer controls provide all control functions including start-up and shut down, leaving chilled water temperature control, compressor and electronic expansion valve modulation, fan sequencing, anti-recycle logic, automatic lead/lag compressor starting and load limiting.

The unit control module, utilizing Adaptive Control™ microprocessor, automatically takes action to avoid unit shutdown due to abnormal operating conditions associated with low refrigerant temperature, high condensing temperature and motor current overload. Should the abnormal operating condition continue until a protective limit is violated, the unit will be shut down. Unit protective functions include loss of chilled water flow, evaporator freezing, loss of refrigerant, low refrigerant pressure, high refrigerant pressure, reverse rotation, compressor starting and running over current, phase loss, phase imbalance, phase reversal, and loss of oil flow.

A menu driven digital display indicates over 20 operating data points including chilled water set point, current limit Set point, leaving chilled water temperature, evaporator and condenser refrigerant pressures and temperatures. Over 60 diagnostic checks are made and displayed when a problem is detected. The digital display can be read and advanced on the unit without opening any control panel doors. Standard power connections include main three phase power and two 115 volt single phase power connections for control power and heat tape.

## Starters

Starters are housed in a weathertight enclosure with removable cover plate to allow for customer connection of power wiring. Wye Delta closed transition starters are standard on all RTAD units.

# Notes

---

# Notes

---



**TRANE®**

Cooling and Heating  
Systems and Services



Quality Management  
System Approval



---

Literature Order Number	RLC-PRC015-E4
Date	1108
Supersedes	RLC-PRC015-E4_0903

---

*Trane has a policy of continuous product and product data improvement and reserves the right to change design and specifications without notice. Only qualified technicians should perform the installation and servicing of equipment referred to in this publication.*

**[www.trane.com](http://www.trane.com)**

For more information, contact your local  
sales office or e-mail us at [comfort@trane.com](mailto:comfort@trane.com)

Trane bvba  
Chaussée de Wavre 1789 - 1160 Brussels, Belgium  
ON 0888.048.262 - RPR BRUSSELS